

# Ultraform® (POM)

Product Brochure



 **BASF**

We create chemistry

## Ultraform® (POM)

Ultraform® is the trade name for the range of thermoplastic polyoxymethylene copolymers from BASF.

The Ultraform® product family encompasses versatile engineering plastics with a wide variety of characteristics, which are designed for use in complex and heavy-duty components. Ultraform® grades offer everything you need from an engineering material: they combine high rigidity and strength with superb resilience, favorable sliding friction characteristics and good dimensional stability, even under the influence of mechanical forces, in contact with many chemicals, fuels and other media, and at elevated temperatures.

## Main Application Areas of Ultraform®

- Automotive applications (e.g. sensor components, loudspeaker grids, clips and fasteners, spring elements)
- Everyday articles (e.g. shower head inserts, furniture fittings, coffee machine brewing units, zippers, pipe connectors, functional parts in door/window handles and toys)
- Industrial applications (e.g. ball bearings, gear wheels, links and connecting elements in conveyor chains and belts)
- Functional elements in medical devices (e.g. inhalers, Auto-injectors, Insulin pens, clips and clamps)

# Ultraform® (POM)

ULTRAFORM® IN AUTOMOTIVE APPLICATIONS		4-5
ULTRAFORM® IN EVERYDAY APPLICATIONS		6-7
ULTRAFORM® IN INDUSTRIAL APPLICATIONS		8
ULTRAFORM® IN MEDICAL APPLICATIONS		9
THE PROPERTIES OF ULTRAFORM®		10-21
	Mechanical Properties	10
	Impact Strength	12
	Behavior under Cyclic Loads, Flexural Fatigue Strength	14
	Tribological Properties	14
	Thermal Properties	16
	Behavior on Exposure to Light and Weather	17
	Resistance to Water, Fuels and Chemicals	18
	Sterilization	19
	Behavior on Exposure to High-Energy Radiation	20
	Fire Behavior	20
	Electrical Properties	20
	Product Line	20
THE PROCESSING OF ULTRAFORM®		22-33
	General Notes	22
	Compatibility with other Thermoplastics	23
	Injection Molding	24
	Injection Unit	24
	Injection Mold	25
	Mold Temperature Control	26
	Processing by Injection Molding	26
	Fabrication and Finishing Processes	32
GENERAL INFORMATION		34-38
	Safety Notes	34
	(Integrated) Management System	35
	Nomenclature	36
	Technical ID	36
	Subject Index	37

# Ultraform® in Automotive Applications

Ultraform® gives designers an engineering plastic that shows many of the properties required in the automotive industry. Ultraform® offers excellent fuel and chemical resistance, low swelling, good long-term thermal stability and electrical insulation capacity.

Ultraform® has long been successfully used in numerous applications in the automotive industry, for instance:

- in the fuel system for tank caps
- in components of fuel-carrying modules (flanges, fuel pumps, filter housings, swirl pots)
- for level gauges
- in tank venting systems (roll-over valves) for the steering and controls of torque roll restrictors
- ball cups and ball bearings
- levers
- linkages
- sensor components in the interior for loudspeaker grids
- clips
- fastening
- spring elements
- pushbuttons
- deflection fittings
- head rest guide
- sun visors and mechanical parts in safety belts

## In doors and windows:

- for components to raise and lower windows and for the cranks of sliding sunroofs

## On the exterior:

- for clips and elements for fastening add-on parts
- for windshield wiper clips
- windshield washer nozzles
- electromechanical adjustment mechanisms for mirrors and headlights

## In the engine compartment:

- for clips located away from the engine and for fastening elements

## In E&E:

- in electronics for clips
- fastening elements and plug-in connectors



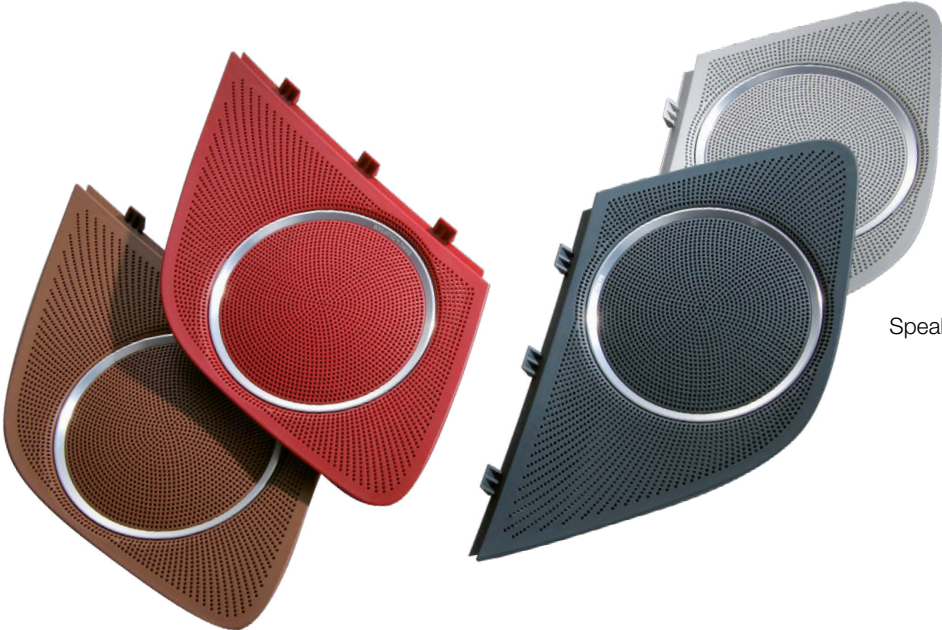

Speaker grills



Mirror actuator



Liquid trap

Seatbelt clip



# Ultraform® in Everyday Applications

Thanks to its outstanding mechanical properties at elevated temperatures, and its chemical resistance and long term stability, Ultraform® demonstrates exemplary performance in many everyday applications. Ultraform® enhances the performance of different applications such as furniture, coffee machines and even sports and leisure applications.

Brewing unit



Drainage tube in coffee machines



## Applications include:

- parts of plumbing fixtures
- inserts for shower heads
- components in watering
- components in irrigation systems
- gas meter housings
- sliding and fastening parts for curtains
- part of office chairs
- functional parts in the hardware of doors and windows
- clasps, clips, and fastening elements in sports and recreation
- shock-absorbing elements in washing machines
- functional parts and inserts in dishwashers
- components in vacuum cleaners
- tablet dispensers/cosmetic packaging
- functional parts in toys: springs, clamps, gear wheels, motor and gear modules, sliding elements
- functional parts in furniture joints and drawer runners
- furniture fittings
- zippers



Gas meter housing



Toilet flush

Pipe connector



Spring clip

# Ultraform® in Industrial Applications

Owing to its extremely versatile and tailor-made properties as well as its high reliability even under demanding conditions, Ultraform® is used in numerous industrial applications including machine and plant construction as well as precision engineering. Fastening elements, ball bearings, gear wheels, gear parts, valves, impellers, deflection rollers, thread guides for textile machines, links and connecting elements in conveyor chains and belts are only a few examples of Ultraform® applications.

## Skate wheel for conveyor systems

The inherent characteristic of Ultraform® gives the product the advantage of being light-weighted, corrosion resistant and naturally lubricated. Therefore, no extra grease is needed anymore, which reduces maintenance and washdowns are no longer a problem.

## Plastic bearing with integrated gear teeth for ATM

By opting for a plastic material for this component, our customers benefit from the way molded gear teeth can be combined into the outer race of the bearing. This structure can be applied alongside with clips and fixing features, which reduces the number of components, costs, and assembly time.

## Plastic bearing with integrated features for steering column

We have used plastic material selection to push the boundaries of plastic injection molding and innovation, designing plastic steering column bearings that help reduce weight and fuel efficiency by using lightweight materials and molding integrated mating components into the bearing to reduce assembly weight.

## Plastic rolling element bearing

Our customers have been designing and molding plastic bearings for over 50 years. Plastic materials show many advantages over their metal equivalents, such as being inherently lubricated (no need for grease or lubricants) and non-magnetic, weighing less and being resistant to corrosion and chemicals.



Skate wheel for roller conveyor



Dishwasher basket bearing



Plastic bearing with integrated features for steering column



Plastic bearing with integrated gear teeth for ATM



Plastic rolling element bearing



# Ultraform® in Medical Applications

Ultraform® PRO is adapted specifically for the requirements and needs of the medical industry. The suffix PRO (Profile Covered Raw Materials Only) expresses that only very specific raw materials that are subject to strict controls are used, and points to an expanded service package for medical technology, also including formulation consistency.

Ultraform® PRO is ideal for use with functional components such as valves, springs, gears and snap-in mechanisms. Furthermore, for guiding and sliding elements which are used in various substance contributor systems, for example in insulin pens, inhalers, auto-injectors, and dispensers.



Skin stretcher



Implantation aid



Drug delivery devices



Insulin pen

# The Properties of Ultraform®

Ultraform® is part of the engineering plastics family due to its properties. It can be processed as a thermoplastic and has a partially crystalline structure with a high degree of crystallization. Ultraform® is produced by the copolymerization of trioxane and another monomer. It consists of linear chains in which the co-monomers are firmly incorporated in a statistically distributed manner. These co-monomer units account for the high stability of Ultraform® during processing and when exposed to long-term heat and to chemicals. It surpasses, by far, the resistance of homopolymeric polyoxymethylene.

## Mechanical Properties

What makes Ultraform® special, is its ideal combination of strength, stiffness and toughness, all of which can be ascribed to the structure of the product. Owing to its high crystallinity, Ultraform® is stiffer and stronger than other engineering plastics, especially within the temperature range from 50 °C to 120 °C. Ultraform® does not undergo any transitions between the low glass-transition temperature of approximately -65 °C and the melting temperature of approximately 170 °C. This translates into relatively constant mechanical properties over a wide temperature range that is very attractive from a technical point of view (Fig. 1).

At room temperature, Ultraform® has a pronounced yield point at about 11 % strain. Below this limit, Ultraform® exhibits good resilience, even under repeated loading, and is therefore especially suitable for elastic elements.

In addition, it has high creep strength and a low tendency to creep (Fig. 2).

This combination of characteristics in association with good tribological properties makes it very suitable for engineering applications.

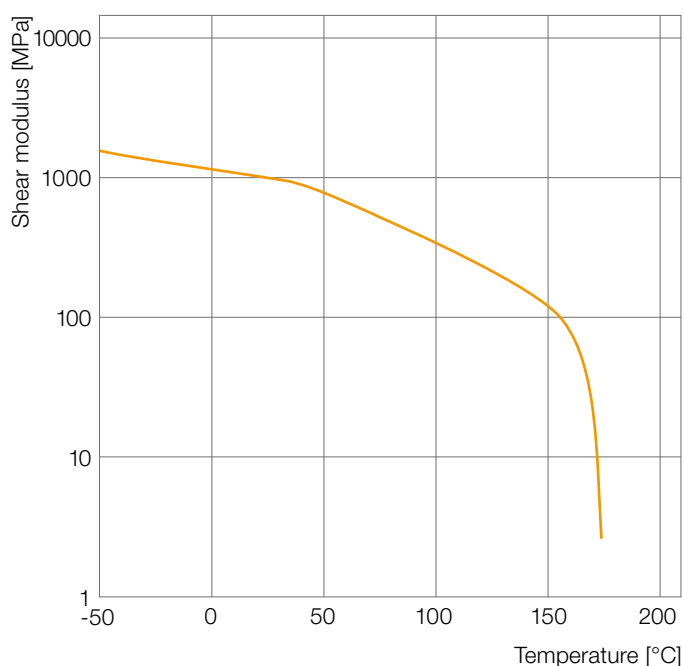

Fig. 1: Shear modulus of Ultraform® N2320 003 AT UN as a function of the temperature (measured according to ISO 6721-7)

Ultraform® absorbs very little water: approx. 0.2% under normal conditions (DIN EN ISO 291) and only approx. 0.9% on complete saturation with water at 23°C.

The mechanical properties can be widely varied by employing suitable elastomeric additives, mineral fillers and glass fibers. Elastomer-modified Ultraform® grades largely retain their POM-like properties but exhibit a substantially higher level of impact resistance and a higher energy absorption capacity. Depending on the degree of modification, the rigidity, and hardness of these grades is reduced.

Mineral-filled and especially fiberglass-reinforced Ultraform® grades, in contrast, exhibit increased strength, stiffness, and hardness.

### Behavior under long-term static loading

The tensile creep test in accordance with ISO 899-1 and the stress relaxation test in accordance with DIN 53441 provide information about extension, mechanical strength and stress relaxation behavior under sustained loading.

The results are illustrated as creep modulus plots (Fig. 2) and creep curves (Fig. 3) for BASF's main grade N2320 003 AT UN.

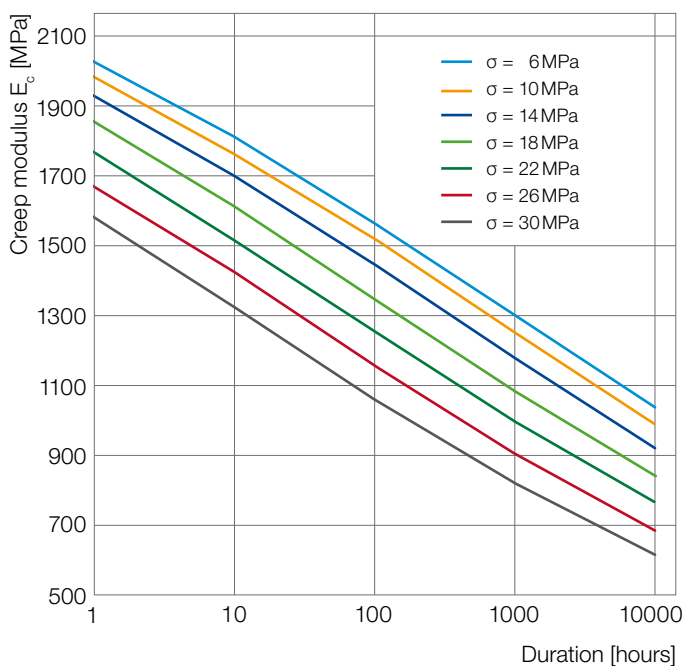

Fig. 2: Creep modulus  $E_c$  of Ultraform® N2320 003 AT as a function of loading duration (measured in accordance with ISO 899-1 under standard climatic conditions, 23°C/50% r.h.)

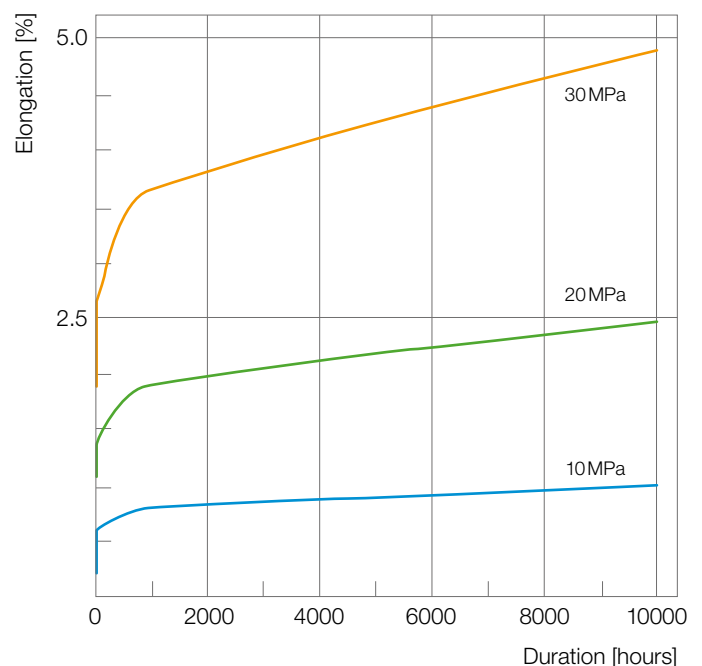

Fig. 3: Creep curves for Ultraform® N2320 003 AT at 23°C, measured in accordance with ISO 899-1

Figs. 4 and 5 show the isochronous stress-strain curves for standard and glass-fiber reinforced Ultraform® at 23 °C.

The graphs reproduced here are just a selection from our extensive collection of test results. Further values and diagrams for different temperature and atmospheric conditions can be obtained from the Ultra-Infopoint.

Design data obtained from uniaxial tensile loading tests can also be used to assess a material's behavior under multiaxial loads.

The web-based calculator "Snap-Fit Design" developed by BASF can be used for analysis of snap elements subjected to flexural load.

Fig. 6 shows creep rupture curves for selected Ultraform® grades at 60 °C.

### Impact Strength

Parts made from Ultraform® remain impact-resistant over a wide range of temperatures. Due to its very low glass transition temperature (about -65 °C) Ultraform® still exhibits outstanding impact resistance and adequate notched impact resistance at temperatures as low as -30 °C.

Impact-resistant grades with graduated modification are available for applications with high demands on toughness. Fig. 7 shows a plot of impact strength versus rigidity for these and other grades. A substantial gain in impact strength is obtained at the expense of a moderate loss in rigidity.

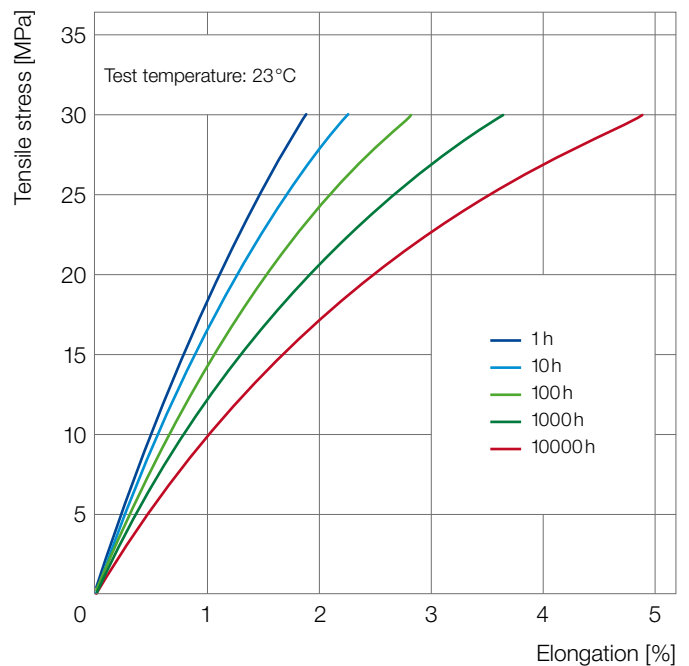

Fig. 4: Isochronous stress-strain curves for Ultraform® N2320 003 AT, measured in accordance with ISO 899 -1

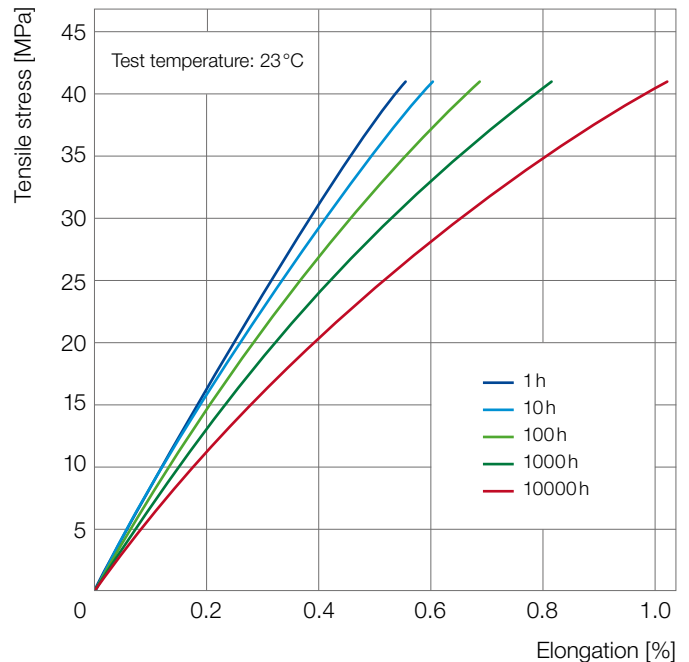

Fig. 5: Isochronous stress-strain curves for Ultraform® N2200 G53 AT, measured in accordance with ISO 899-1

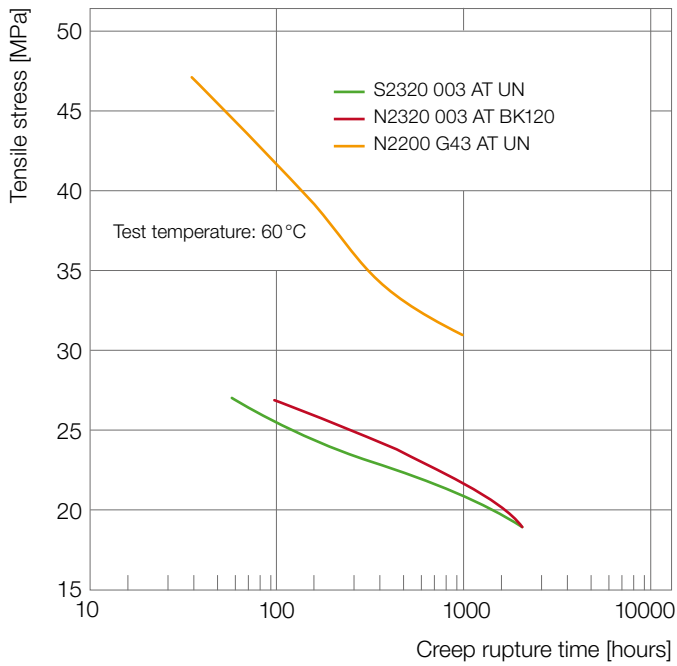

Fig. 6: Creep rupture curves for selected Ultraform® grades at 60 °C

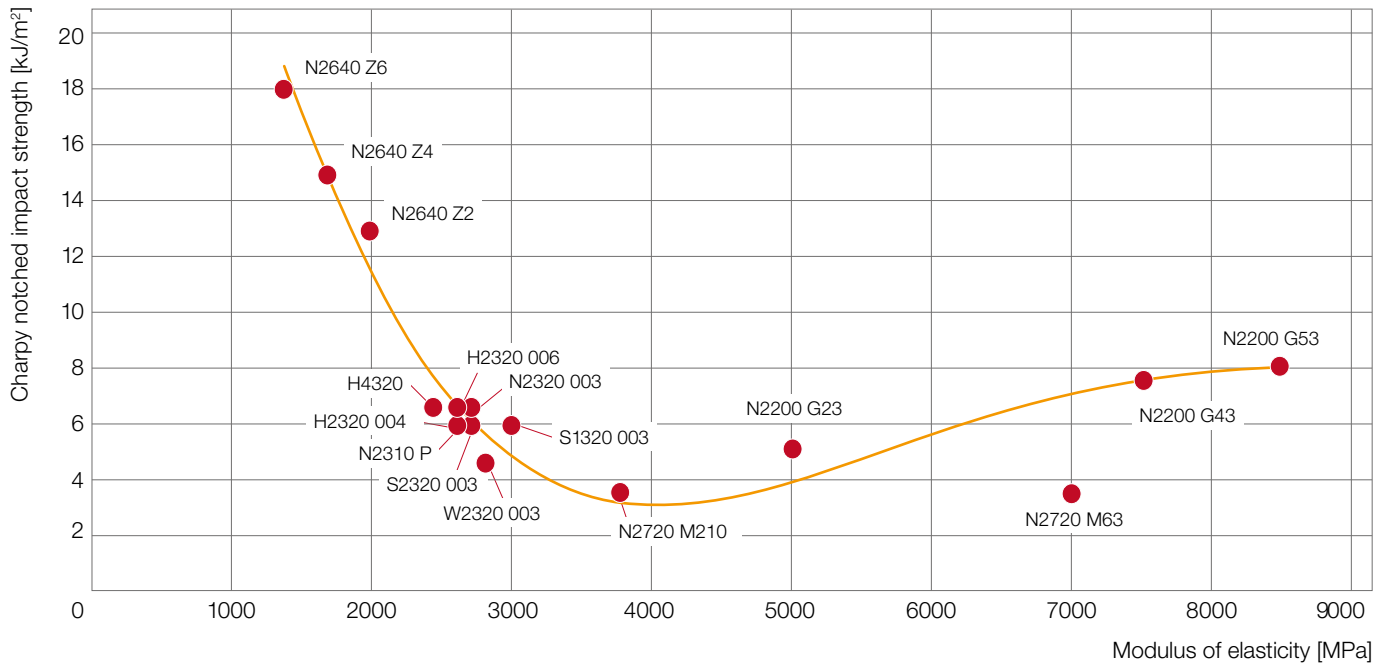

Fig. 7: Impact strength vs. stiffness for selected Ultraform® AT grades

## Behavior under Cyclic Loads, Flexural Fatigue Strength

Engineering parts are frequently subjected to stress by dynamic forces, especially alternating or cyclic loads, which act periodically in the same manner on the structural part. The behavior of a material under such loads is determined in fatigue tests in flat bending, rotating bending tests or tension/compression (DIN 50100) up to very high load-cycle rates. The results are presented in what are known as Wöhler diagrams obtained by plotting the applied stress against the load-cycle rate achieved in each case. Fig. 8 shows the Wöhler diagram for unreinforced and reinforced Ultraform® under tension mode with  $R=0.1$ .

The flexural fatigue strength is defined as the stress level a sample can withstand for at least  $10^7$  cycles.

When the test results are applied in practice, it has to be taken into account that at high load alternation frequencies, the workpieces may heat up considerably due to internal friction. In such cases, just as at higher operating temperatures, lower flexural fatigue strength values have to be expected.

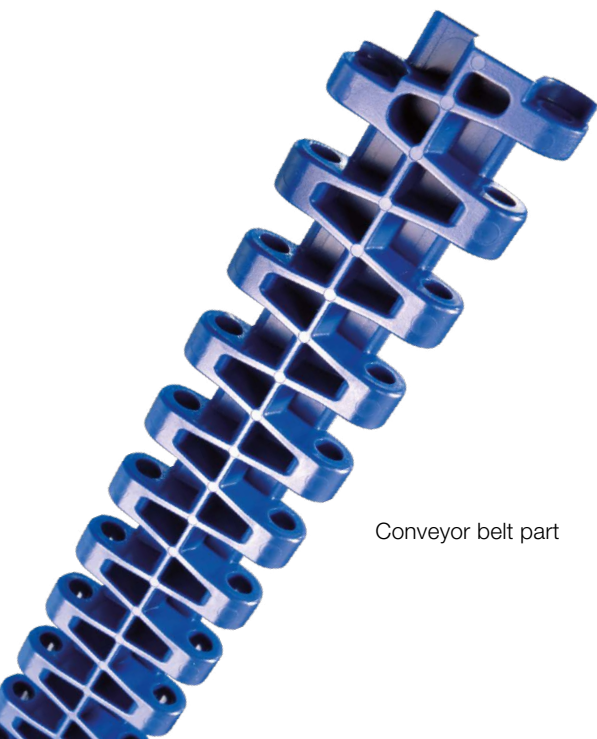

Conveyor belt part

## Tribological Properties

Friction and wear are system properties and not properties of a single material. The tribological behavior of systems cannot be characterized by parameters derived from the involved pure substances. Friction and wear are affected by a multitude of parameters, e.g. the nature of the sliding partner, the microstructure of the sliding surface (roughness), the intermediate layer (external lubricant), the surface pressure, and the relative velocity of the sliding partner. Tribological tests nevertheless permit a general estimation of material behavior. In order to evaluate wear behavior, e.g. block-on-ring tests can be used.

Ultraform® is a suitable material for sliding elements due to its excellent sliding properties and very high resistance to wear. Due to the smooth, hard surface and highly crystalline structure of Ultraform®, even standard grades show good tribological properties. In case the application is more demanding, the Ultraform® portfolio offers a good range of tribological modified grades that provide solutions for a variety of tribological systems.

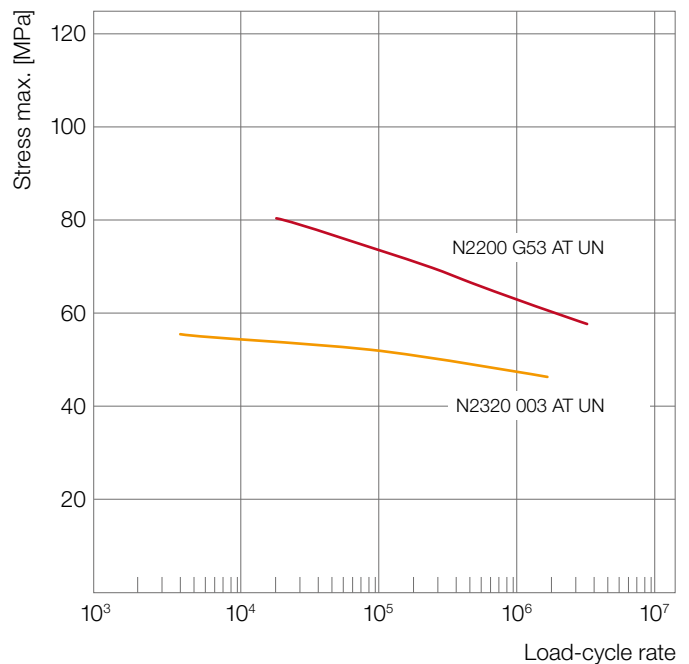

Fig. 8: Wöhler diagram for unreinforced and reinforced Ultraform® determined in the tensile fatigue tests in accordance with DIN 50100. Normal climatic conditions 23/50 in accordance with DIN EN ISO 291, load cycle frequency 10 Hz,  $R=0.1$

Even in the case of solid friction, only slight wear is to be expected at the coefficients of sliding friction likely to be in operation. The coefficient of sliding friction of Ultraform® becomes smaller as the surface roughness of the paired material increases, but wear caused by sliding friction will increase. The special grades of Ultraform® W2320 003 TR AT, W2310 TR AT, N2310 P AT, N2770 K AT and N2720 M210 AT display a marked improvement in their sliding and abrasion behavior. N2720 M210 AT exhibits optimal properties, even at elevated surface pressures or greater roughness of the sliding counterpart. Table 1 shows a general overview of the grades and their specific tribological performance.

Ultraform® W2310 TR AT shows good tribological performance in contact with metal as well as plastic surfaces. Figure 9 and 10 show the coefficient of sliding friction as a function of the sliding speed for both types of counter materials. In addition, the special tribological additive leads to very low stick-slip tendency and reduces noise generation in the tribological system.

S2320 003 PRO TR AT UN	Tribological grade for medical applications in contact with POM, PA and PBT, when only slight improvement of sliding characteristics is needed
S2320 003 TR R01 AT UN	Special grade with high tribological performance, helps to avoid additional external lubrication
W2310 TR AT UN	Multipurpose product, good performance vs. steel and vs. POM <ul style="list-style-type: none"> <li>■ reduces wear and COF</li> <li>■ reduced stick-slip &amp; squeaking noise (/POM)</li> </ul>
N2310 P AT UN	1 <sup>st</sup> choice in combination with steel ( $R_z < 2$ ) <ul style="list-style-type: none"> <li>■ reduces wear and COF</li> </ul>
W2320 003 (PRO) TR AT UN	1 <sup>st</sup> choice in combination with POM, PA and PBT <ul style="list-style-type: none"> <li>■ reduces wear and COF</li> <li>■ reduced stick-slip &amp; squeaking noise (/POM)</li> <li>■ also available as medical „PRO“ version</li> </ul>
<b>Special grades for combination with steel to reduce wear &amp; highly loaded gears</b>	
N2770 K AT UN	1 <sup>st</sup> choice at low temperature, medium load ( $p = 1-2 \text{ MPa}$ )
N2720 M210 AT UN	1 <sup>st</sup> choice in case of high roughness and/or high hardness of tribo partner and/or high velocity
N2720 M63 AT UN	1 <sup>st</sup> choice in case of high hardness of tribo partner, high velocity

Table 1: Overview of tribological Ultraform® grades

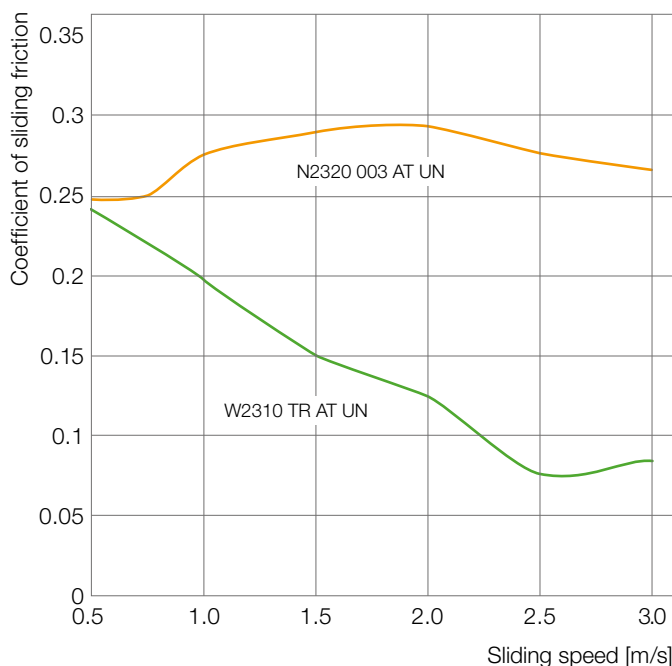

Fig. 9: Coefficient of sliding friction of Ultraform® N2320 003 AT and W2310 TR AT as a function of the sliding speed. Sample technically dry. Sliding counterpart: Ultraform® N2320 003 AT UN, max. 57 °C,  $p = 0.125 \text{ MPa}$

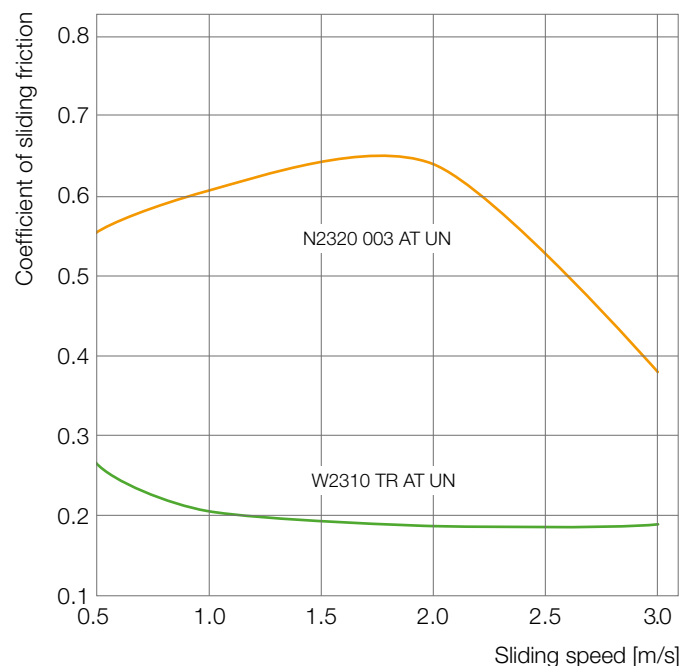

Fig. 10: Coefficient of sliding friction of Ultraform® N2320 003 AT and W2310 TR AT as a function of the sliding speed. Sample technically dry. Sliding counterpart: steel 100Cr6, HRc ca. 60, max. 67 °C,  $p = 4 \text{ MPa}$

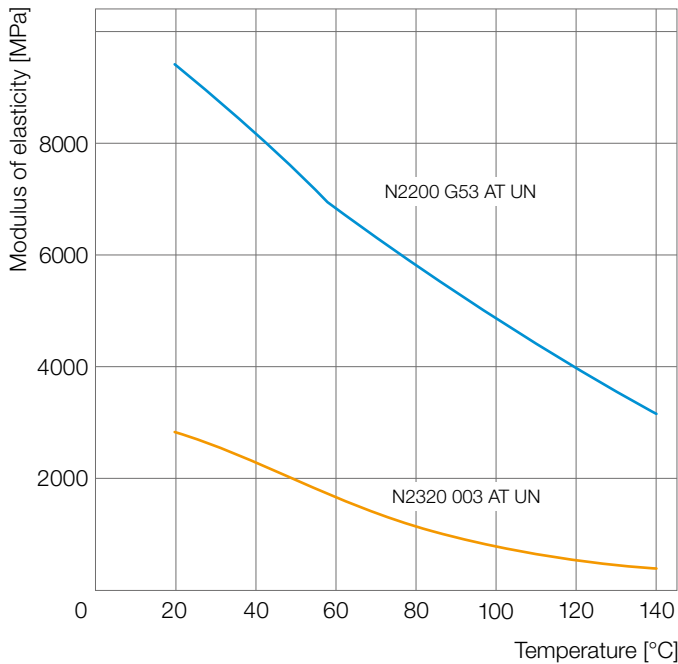

Fig. 11: Modulus of elasticity of unreinforced and reinforced Ultraform® measured in accordance with ISO 527 as a function of temperature

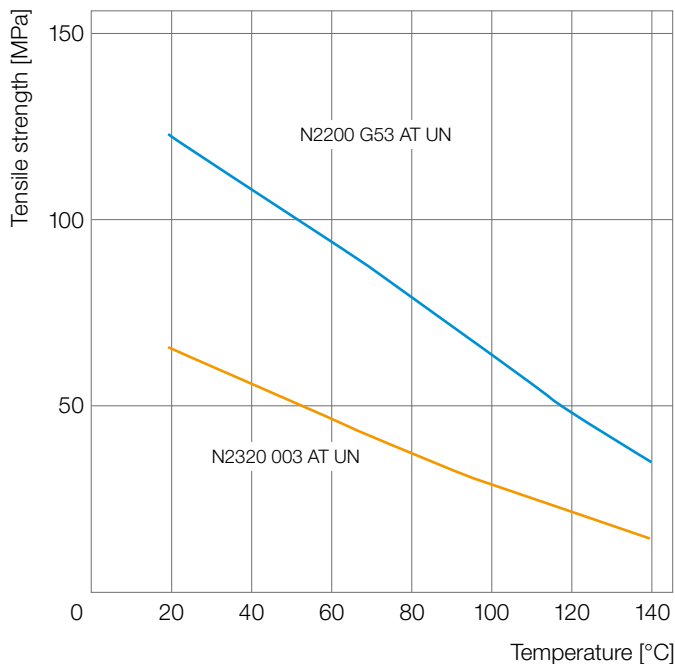

Fig. 12: Tensile strength of unreinforced and reinforced Ultraform® measured in accordance with ISO 527 as a function of temperature

## Thermal Properties

The standard Ultraform® grades have a narrow melting range of approx. 164°C to 168°C. Up to this melting range Ultraform® moldings can be briefly subjected to thermal stresses without the material being damaged.

Figures 11 and 12 show the influence exerted by temperature on the strength-related properties of this material. At a temperature of 80°C, for instance, Ultraform® N2320 003 AT still displays the strength of high-density polyethylene at room temperature. The advantage of fiberglass-reinforced products such as Ultraform® N2200 G53 AT in terms of stiffness and strength is retained, even at an elevated temperature.

The long-term thermal stability of Ultraform® in air is also exceptionally high, as 12-month storage tests at 100°C and 120°C have shown (Fig. 13). From these, a maximum long-term service temperature of approximately 100°C can be derived.

Parts made from glass-fiber reinforced Ultraform® can withstand prolonged exposure to temperatures of up to 120°C without deterioration in material properties due to heat aging (Fig. 14).

It has to be expected that sustained exposures to temperatures above 110°C will eventually cause discoloration. Ultraform® also exhibits good long-term thermal stability in the presence of water, neutral oils, greases, fuels and many solvents.



## Behavior on Exposure to Light and Weather

When POM is used in the open air, the general sensitivity to UV radiation has to be borne in mind. After prolonged exposure to sunlight, the parts lose their surface gloss and become brittle. Treatment with UV stabilizers, as in Ultraform® N2320 U03 AT for example, approximately doubles the service life. Certain pigments e.g. carbon black can also provide additional protection.

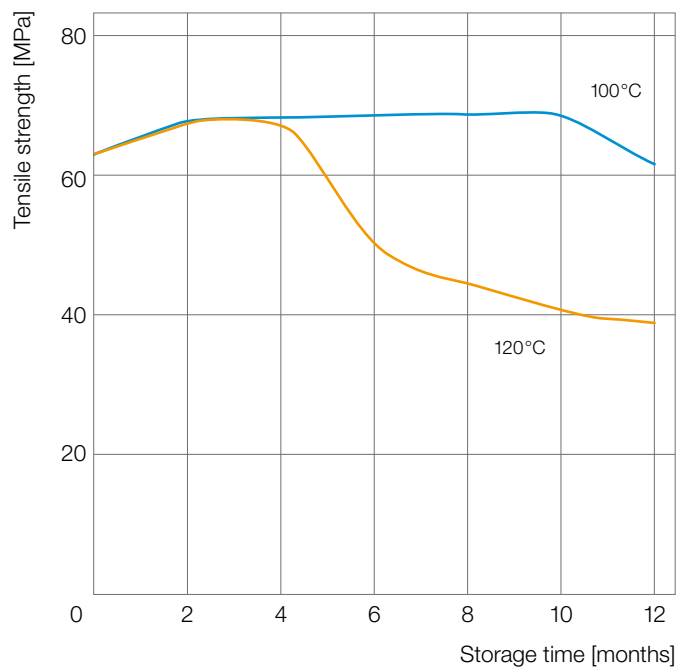

Fig. 13: Storage in air at 100°C and 120°C. Yield stress of Ultraform® N2320 003 AT as a function of the aging period (measured in accordance with ISO 527, v = 50 mm/min.)

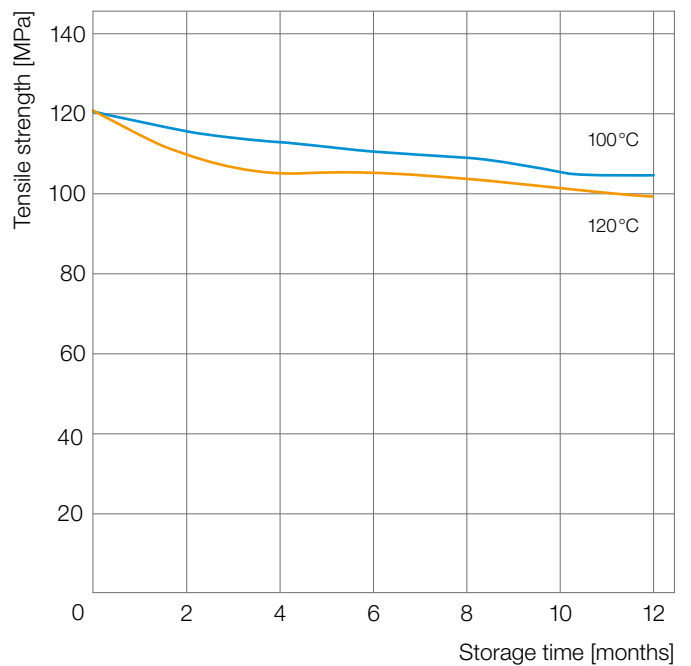

Fig. 14: Tensile strength of Ultraform® N2200 G53 AT measured in accordance with ISO 527 as a function of the storage period at 100°C and 120°C

## Resistance to Water, Fuels and Chemicals

A polymeric thermoplastic material is chemically resistant to certain ambient conditions if the surrounding medium does not cause any degradation, that is to say, a reduction of the molecular weight or a shortening of the polymer molecules. The chemical resistance depends on the concentration, on the duration of exposure and on the temperature of the medium. The swelling (reversible absorption and release of a substance, for example, a solvent) and the stress crack formation (disentanglement of convoluted polymer molecules without chemical degradation) have to be distinguished from the chemical resistance.

Ultraform® displays good to very good long-term chemical resistance against the following media: water, washing liquors, aqueous solutions of salts and most of the commonly employed organic solvents (such as alcohols, esters, ketones, aliphatic and aromatic hydrocarbons), fuels (also those containing ethanol and methanol, for example, M15, CM15, CM15A, CM15AP, E85, FAM-B, biodiesel) as well as against fats and oils, braking fluids and coolants, even at elevated temperatures.

Some solvents and fuel components, particularly short-chain alcohols like ethanol and methanol, cause a slight (reversible) swelling.

There are only a few solvents that are known to dissolve Ultraform®, and this usually only takes place at elevated temperatures.

Stress cracking formation due to solvents or other chemicals is not known to occur in Ultraform®.

Figures 15-18 show the outstanding resistance of Ultraform® when exposed to hot water and fuels. This advantage makes Ultraform® suitable for many applications, for example, in the plumbing sector, in espresso and coffee-making machines, in dishwashers as well as in vehicle fuel systems.

Ultraform® is attacked by oxidizing agents and organic and inorganic acids (pH < 4).

Contact with strong acids (e.g. hydrochloric acid, sulfuric acid) should be avoided at all costs. On the other hand, alkalis have no effect, even at elevated temperatures.

Detailed information can be found in the brochure “Ultramid®, Ultradur® and Ultraform® – Resistance to Chemicals” and can also be obtained at the Ultra-Infopoint.

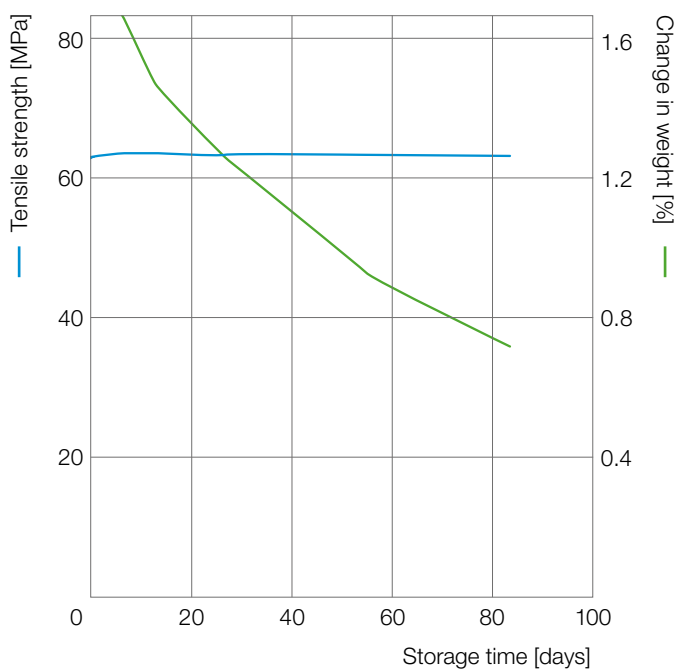

Fig. 15: Change of weight and tensile strength of N2320 003 AT UN by storage in water at 100°C

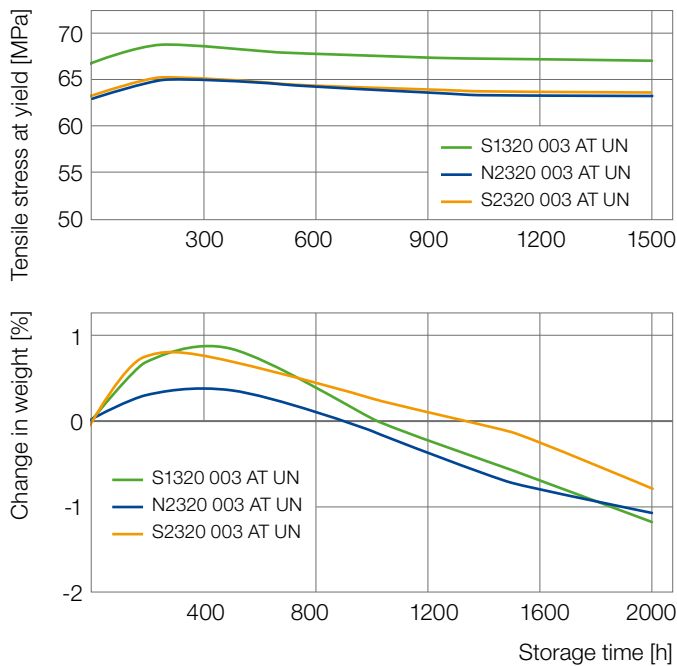

Fig. 16: Ultraform® shows strong stability in harsh diesel environment – biodiesel DIN EN 14214 at +100 °C

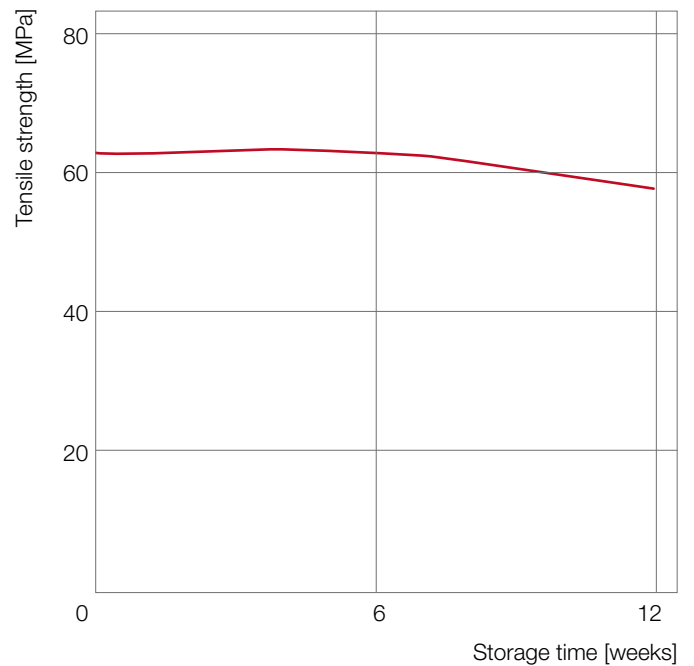

Fig. 18: Storage of Ultraform® S2320 003 AT UN in E50 at 70 °C

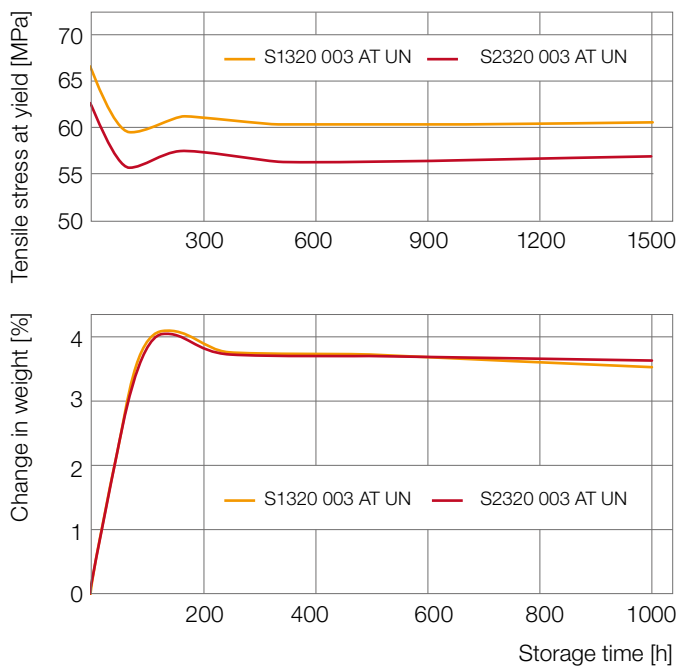

Fig. 17: Storage of Ultraform® S2320 003 AT UN and S1320 003 AT UN in test fluid FAM B (Mixture of 10-25% Methanol, 1-5% Ethanol, and 70-89% CxHy) at 70 °C

### Sterilization

Properly and flawlessly manufactured parts made of Ultraform® can be sterilized in hot steam at 121 °C and, with some limitations, even at 134 °C, over the course of many cycles, whereby the high-molecular grades perform best.

121 °C	suitable/resistant (depending on duration and number of cycles)
134 °C	limited suitable/resistant (depending on duration and number of cycles)

Repeated sterilization using plasma and ethylene oxide for Ultraform® is suitable without loss/impact in mechanical performance. In the case of ethylene oxide, a potential risk is given in terms of absorption and release of toxic ethylene oxide.

Great caution is advisable in the case of sterilization using ionizing radiation. Chemical disinfection is not recommended.

### Behavior on Exposure to High-Energy Radiation

Polyacetals are only moderately resistant to electron and gamma rays. Ultraform® behaves fundamentally in the same way with respect to these two types of radiation. Depending on the total radiation dose, a more or less pronounced degradation occurs, along with brittleness. A total dose of 25 kGy (2.5 Mrad) can already affect the mechanical properties and the color of the parts.

### Fire Behavior

Polyacetals ignite on exposure to flame and continue to burn after the ignition source has been removed. A flame-retardant treatment is not available.

Ultraform® has a UL 94 flammability rating of “HB”.

The combustion rate required by FMVSS 302 of <100 mm/min is met by Ultraform® test specimens having a thickness of 1.0 mm and over.

### Electrical Properties

Ultraform® has good electrical insulation properties and high dielectric strength. The very low moisture absorption of the material does not impair this property, making parts made from Ultraform® highly suitable for use in consumer electronics and telecommunications.

In the field of electric power engineering, Ultraform® is widely used for functional and drive parts which are not used directly as supports for current-carrying parts.

### Product Line

The Ultraform® product line encompasses grades for processing by means of extrusion and injection molding. The following product groups exist:

#### Extrusion grades

- H2320 004 AT for thin-walled semi-finished parts
- H4320 AT for thick-walled semi-finished parts

H4320 can also be used for the injection molding of thick-walled, nearly void-free parts.

Viscosity	High	Medium		Low
Grade	H	N	S	W
Extrusion	H4320 AT UN H2320 004 AT UN			
Standard Injection Molding	H2320 006 AT UN H2320 008 AT UN (only US Market)	N2320 003 AT UN/BK	S2320 003 AT UN/BK	W2320 003 AT UN/BK
UV Stabilized	N2320 U03 UN			
Low Emission	N2320 0035 LEV AT UN      S2320 003 LEV AT UN      W2320 U035 LEV AT UN			
High Stiffness/ HDT	S1320 003 AT UN/BK			
Optimized Self-Coloring	N2320 003 SC AT UN			
Drinking Water	H4320 AT UN	N2320 AQUA AT UN	S2320 AQUA AT UN	
Medical Applications	N2320 003 PRO AT UN      S2320 003 PRO AT UN      W2320 003 PRO AT UN			

Table 2: Ultraform® unreinforced standard grades in various viscosity classes

### Standard injection-molding grades

in various viscosity classes. As a rule, they can be processed rapidly, without deposits and are also easy to demold.

H2320 006 AT	for thick-walled parts
N2320 003 AT	standard grade
S2320 003 AT	easy flowing
W2320 003 AT	very easy flowing

### Impact-modified injection-molding grades

for applications that make particularly high demands in terms of the toughness. There are TPU-modified grades (N2640 Z2/Z4/Z6), each with differing contents of impact modifiers.

### Mineral-filled injection-molding grades

with differing mineral contents for low-warpage and dimensionally stable molded parts that display increased stiffness, hardness and heat distortion resistance.

### Glass fiber-reinforced injection-molding grades

with differing glass fiber contents for applications entailing very high demands in terms of strength, stiffness, hardness, creep resistance and dimensional stability under heat.

### Tribological injection-molding grades

are suitable for plastic components in applications where optimized sliding and/or abrasion characteristics are necessary. Available grades cover a variety of tribological modifications to offer products suitable for a broad range of tribological systems.

### Grades with special treatment for purposes of

- improving light resistance, UV resistance and weathering resistance (N2320 U03 AT, W2320 U035 LEV AT)
- enhancing the fatigue strength against diesel fuel at high temperatures (S1320 003 AT)
- producing especially low-odor parts, e.g. for the interior of vehicles (N2320 0035 LEV AT UN, N2640 Z4 LEV2 AT BK 140)

A detailed overview of the product line can be requested from the Ultra-Infopoint.

Impact Modified		Functional			Reinforced	
TPU	Tribology	Laser marking	Pre-colored	Glass	Mineral	
N2640 Z2 AT UN/BK	N2310 P AT UN			N2200 G23 AT UN		
N2640 Z4 AT UN/BK	N2770 K AT UN			N2200 G43 AT UN/BK		
N2640 Z6 AT UN	S2320 003 R01 AT UN			N2200 G53 AT UN/BK	N2720 M210 AT UN/BK	
N2640 Z6 R01 UN	S2320 003 PRO TR AT UN	W2320 003 AT BK11020	N2320 003 AT BR90372 (Brown)	N2200 G43 R01 AT UN		
N2644 Z9 AT UN	W2320 003 (PRO) TR AT UN			N2200 G53 R01 AT UN (improved flowability, enhanced mechanic)	N2720 M63 AT UN	
N2640 Z2 LEV2 AT BK						
N2640 Z4 LEV2 AT BK	W2310 TR AT					

Table 3: Ultraform® specialty compounds

# The Processing of Ultraform®

Ultraform® can be processed by all methods suitable for thermoplastics. The most important methods are injection molding and extrusion. Injection molding allows even the most complicated moldings to be mass-produced very economically. The extrusion process is used to manufacture rods, pipes, profile sections and sheets, most of which are further machined by cutting tools to form finished parts.

In the following, different topics about the processing of Ultraform® will be elaborated. Further information can be found on the internet at [www.plastics.basf.com](http://www.plastics.basf.com) or via the Ultra-Infopoint ([ultraplaste.infopoint@basf.com](mailto:ultraplaste.infopoint@basf.com), [infopoint.northamerica@basf.com](mailto:infopoint.northamerica@basf.com), [ultraplastics.infopointasia@basf.com](mailto:ultraplastics.infopointasia@basf.com)). Detailed processing information can be found in the respective processing data sheets.

## General Notes

### Preliminary treatment

The granules or pellets in their original packaging can generally be processed without any special preliminary treatment. However, granules or pellets which have become moist due to prolonged or incorrect storage must be dried in suitable dryers, e.g. dehumidifying dryers, for approx. 3 hours at about 100 °C to 110 °C.

### Start-up and shutdown

The processing machine containing Ultraform® is started up in the usual manner for thermoplastics. The barrel and nozzle heaters are set to achieve melt temperatures of 180 °C to 220 °C. After this the optimum processing conditions must be determined in trials. See also "Safety notes".

When there are relatively long work stoppages or a shut down, if possible, run the machine empty and reduce the barrel temperature.

When the processing machine is re-started, care should be taken to ensure that the die is first heated up to about 200 °C. This measure prevents blockage of the machine and hot runner nozzle by a cold plug of material.

### Self-coloring

Ultraform® can be colored during processing. These aspects should be considered in this context:

- Only colorants and auxiliaries that do not affect the thermal stability of Ultraform® and that are themselves stable under the prevailing processing conditions can be utilized to color Ultraform®.
- In actual practice, coloring systems on the basis of powdered pigments, liquid colors and masterbatches (polyolefin or preferably POM substrate material) are successfully employed. Uniformity of the color distribution can usually be achieved by means of elevated back pressure.
- The presence of pigments (type and amount) as well as the presence of a masterbatch support material alter the mechanical and tribological properties as well as shrinkage and warpage behavior of Ultraform® by comparison with the uncolored material. Tests on finished parts will provide information as to whether the demands made of the parts are being met.
- In most cases, good results can already be obtained with conventionally configured processing installations to which a colorant metering unit has simply been added. If very high demands are being made, it is recommended that special mixing elements are employed.
- If self-colored parts are used in contact with food, the special provisions of food legislation must be observed (see "Safety notes").

Additional information can be found in the brochure "Self-coloring of Ultraform®".

### Re-processing

Ground-up waste material consisting of sprues, rejects and the like can be recovered by mixing it back in. However, they must not be dirty or damaged from the preceding processing. Factors that can influence the material degradation are:

- severe shearing (high screw speeds, gates that are too small, etc.)
- temperature too high or residence time too long
- incompatible pigments used in self-coloring
- foreign material or other impurities
- moisture.

The grinding procedure can also damage the plastic. Mills running at a low speed have proven their worth for the grinding operation; any adhering dust should be removed. Prior to the re-processing, it is recommended to dry any ground-up material that has been stored for a prolonged period of time. In actual practice, 10-15 %, occasionally even up to 30 % of ground-up material, is admixed.

In the case of fiberglass-reinforced products, the glass fibers can be shortened during processing and during grinding. If large quantities of such a type of ground-up material are admixed to the new material, then the shrinkage, the warpage and especially the mechanical properties can be affected.

The addition of ground material to the original granules can adversely affect the normal feed behavior. Therefore, it should only be added to a production run if it is certain that it will not disturb the processing conditions or impair the properties (e.g. impact strength) of the finished parts.

### Compatibility with other Thermoplastics

The Ultraform® grades can be mixed with one another and with other polyoxymethylenes. Due to the limited homogenizing action of the processing machine, excessively large differences in viscosity must be avoided. Ultraform® is immiscible with most other thermoplastics. Even small amounts of such extraneous materials become evident in the form of a laminate structure, particularly around the sprue. The result is the well known delamination effect.

Contamination of Ultraform® by thermoplastics exercising a destructive effect on POM, e.g. PVC, must be avoided at all costs. Mixtures with thermoplastics containing halogen-based flame retardants must also be excluded. Even small amounts can cause uncontrolled and rapid decomposition of Ultraform® during processing.

When ground material is added, it is therefore important to take special care that the material is clean, free of dust and homogeneous.

When changing over to other thermoplastics or from other thermoplastics to Ultraform®, it is advisable to purge the barrel with a granular PE or PP material or suitable cleaning compounds.

In general, once the required temperatures have been set, production can be resumed, the first few moldings being rejected. When changing over from PVC to Ultraform® and vice versa, it is essential to purge the processing machine thoroughly and then clean it mechanically.

## Injection Molding

Injection molding is the most important method for processing Ultraform®. Ultraform® can be processed on all commercial molding machines, provided that the plasticizing unit has been correctly designed.

### Injection Unit

#### Three-section screw

The usual single-flighted, three-section screws are suitable for the injection molding of Ultraform®. In modern machines the effective screw length is 20-23 D and the pitch is 0.8-1.0 D. The tried and tested geometry for three-section screws is shown in Fig. 20. Feed and melt of the granules is substantially determined by the temperature control on the barrel and the depth of the screw flight. Recommended flight depths for different screw diameters are set out in Fig. 21. When using shallow-flighted screws, the plasticizing power is somewhat lower than in standard screws, they pick up less material than deep-flighted screws. However, gentler melt, shorter residence times in the barrel and better homogeneity of the melt are achieved. This yields advantages for the quality of molded parts made from Ultraform®.

Processing in degassing screws is inadvisable.

#### Injection nozzle, non-return valve

An open injection nozzle is generally adequate for the injection molding of Ultraform®. Apart from its simple design ensuring smooth flow, this type of nozzle has the advantage that any gaseous decomposition products formed as a result of thermal damage can escape without pressure build-up. This can arise when residence times are unintentionally long, at high melt temperatures, during stoppages or other interruptions. A shut-off nozzle prevents outflow of the melt during plastication and when the nozzle is retracted from the mold.

For optimum production, the screw should also be equipped with a good-fitting non-return valve to prevent the melt flowing back over the screw flights during the injection and holding pressure phases.

#### Protection against wear

When glass-fiber reinforced Ultraform® is processed, hard-wearing plasticizing units, e.g. bimetallic barrels and armored screws, screw tips and non-return valves, should be used.

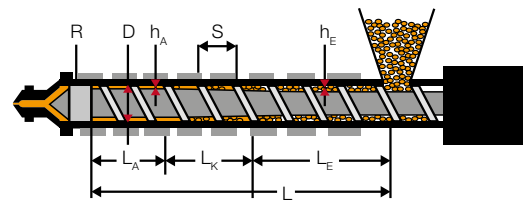

D	outer diameter of the screw		
L	effective screw length	20-23	D
L <sub>E</sub>	length of the feed section	0.5-0.55	L
L <sub>K</sub>	length of the compression section	0.25-0.3	L
L <sub>A</sub>	length of the metering section	0.2	L
h <sub>A</sub>	flight depth in the metering section		
h <sub>E</sub>	flight depth in the feed section		
S	pitch	0.8-1.0	D
R	non-return valve		

Fig. 20: Screw geometry – terms and dimensions for three-section screws for injection-molding machines



## Injection Mold

### Gate and mold design

All known gate types can be used for the injection molding of Ultraform®. The relevant construction guidelines for the design of gates and molds for injection-molded parts made from thermoplastics also apply to Ultraform®. Runners and gates must not be too small.

Due to the low melt viscosity, surface contours are reproduced extremely accurately. Accordingly, the inner surfaces of the mold must be impeccably finished. The same applies to the mold parting surfaces. The parting line must not cause flash formation, but must ensure adequate venting of the mold.

### Use of metal inserts

Metal parts can be overmolded perfectly; however, they should be preheated to between 80 °C and 120 °C before insertion into the mold to prevent residual stress. The metal parts must be free of grease and have knurls, circumferential grooves and the like for better anchoring. Make sure that the metal edges are well bevelled.

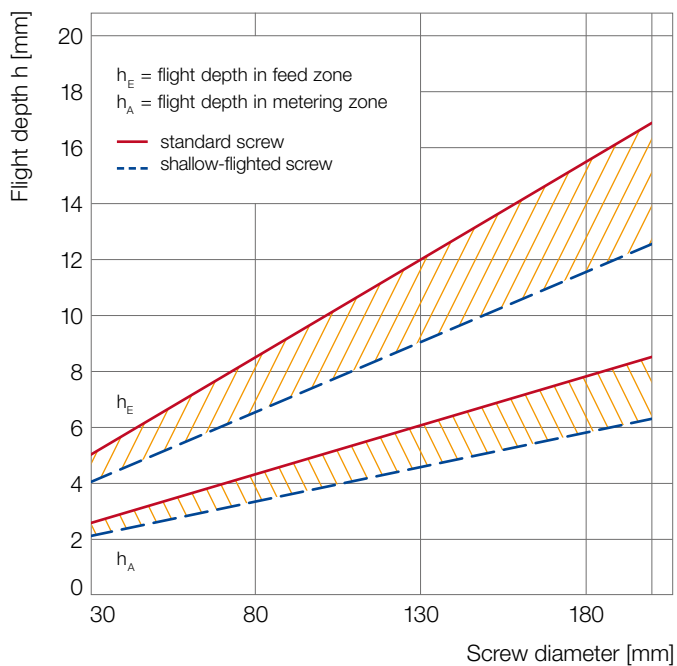

Fig. 21: Screw flight depths for three-section screws in injection-molding machines

## Mold Temperature Control

A well-thought-out and effective temperature control system is of special importance since the temperature of the mold has a major impact on the surface finish, shrinkage, warpage and tolerances of the moldings.

The temperature regulation should be selected in such a way that the same temperature is present in all of the shaping areas. In special cases, it can sometimes be necessary to systematically select divergent temperatures. Thus, for instance, the warpage of the molded parts can be influenced to a certain extent by systematically selecting different temperatures in the mold halves. This is only possible with separate circulation systems.

As with all partially crystalline thermoplastics, it is also the case with Ultraform® that the mechanical properties of an injection-molded article are determined in part by the degree of crystallinity. The crystallinity increases as the mold temperature rises. Hardness, stiffness and strength increase as the mold temperature rises (Fig. 22). The toughness values (Fig. 23) are nearly constant.

Generally speaking, it is sufficient to regulate the temperature within the range from 60°C to 90°C. Precision parts require mold temperatures between 90°C and 120°C. If there is a need for especially high dimensional stability, the mold temperature should be set at least as high as the temperature at which the molded part will be used later on.

To avoid heat loss, it is recommended to provide insulation between the mold and the platen.

## Processing by Injection Molding

### Processing temperature

As a rule melt temperatures of 180°C to 220°C are sufficient. Complex molds with long flow paths and thin walls may in exceptional cases require temperatures up to 230°C. Higher processing temperatures involve the risk of thermal degradation. This is prevented if the production conditions allow a short cycle time and hence a correspondingly low residence time of the melt in the injection molding cylinder. Continuous measurement of the melt temperature by a machine nozzle with an integrated thermocouple is recommended.

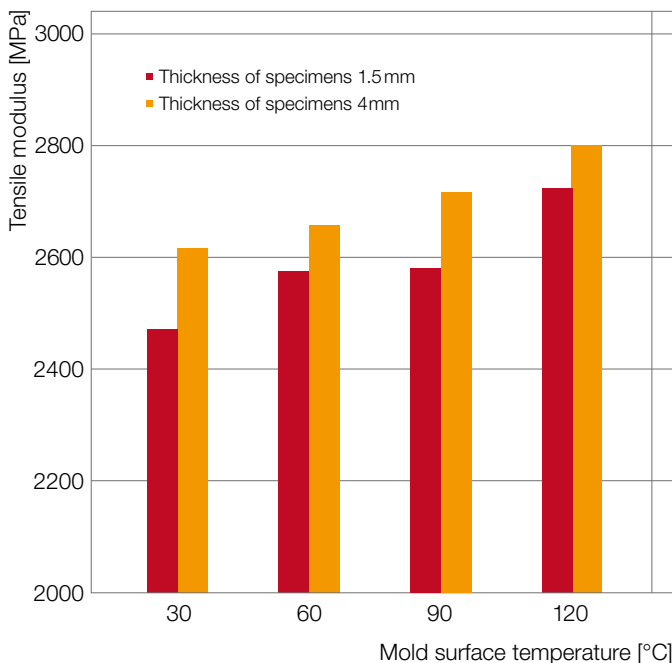

Fig. 22: Ultraform® N2320 003 AT – influence of the mold surface temperature on the stiffness of tensile bars with different thickness

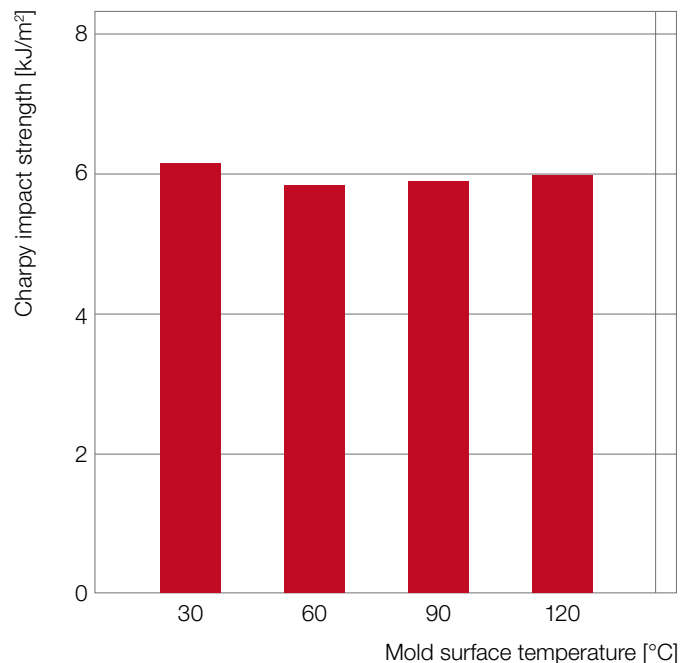

Fig. 23: Ultraform® N2320 003 AT – influence of the mold surface temperature on the charpy impact strength (ISO 179/1eU)

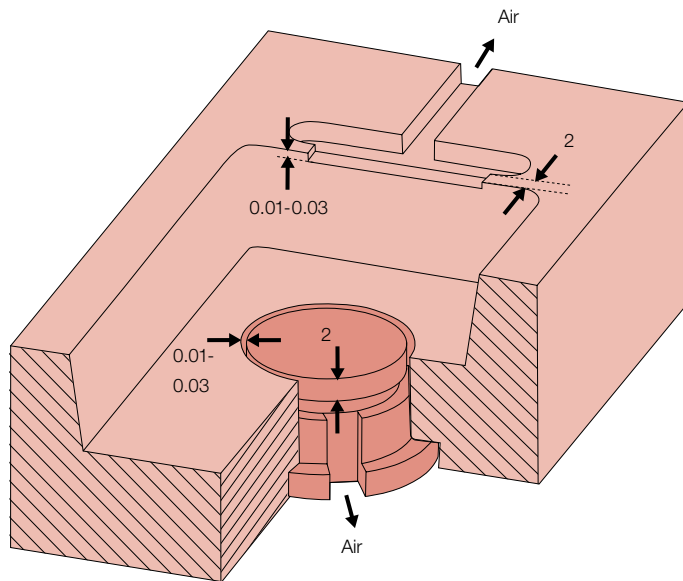

Fig. 24: Mold venting system  
(all dimensions in mm)

The individual heater bands in the injection molding machine can frequently be set to the same temperature. If cycle times are long, the first heater band (near the hopper) should be set to a slightly lower temperature to prevent premature melting of the pellets in the feed zone.

#### Feed characteristics

Ultraform® is drawn in without problem by standard screws (Figs. 20, 21). The screw geometry, screw speed, back pressure and temperature control at the barrel determine the feed behavior of the granules and their plastication.

The cooling near the material hopper, which is available on most injection molding machines, allows the feed behavior to be corrected if necessary. In special cases, a temperature profile falling from the hopper to the nozzle must be set for Ultraform® N2310 P (e.g. 220 °C to 205 °C).

The peripheral speed of the screw should not exceed 0.3 m/s.

#### Mold filling

The quality of the finished parts also depends on the speed at which the mold is filled. A filling rate which is too high promotes alignment of the molecules and results in anisotropic mechanical properties. On the other hand, a filling rate which is too low yields parts with poor surface finish.

To avoid burn marks due to compressed air (Diesel effect), it is necessary that trapped air in the mold cavity can escape at suitable points when the melt is injected. An insufficient ventilation of the mold increases mold deposits. Fig. 24 shows a well-trying system for ventilation.

If material accumulation cannot be avoided by design, shrinkage is counteracted by selecting a holding pressure and holding pressure time high enough to compensate for the volume contraction that occurs when the melt cools. This requires a sufficiently large and favorably located gate. This prevents the compound in this area from solidifying before the end of the holding pressure time and thereby sealing the molded part, which is still plastic on the inside, against the compound to be repressed.

**Flow characteristics**

Ultraform® H4320 AT, the high-molecular-weight resin with the highest viscosity, is a preferred material for extrusion. It is also suitable, however, for the production of particularly tough injection-molded parts with relatively thick walls (>3 mm).

Ultraform® N2320 003 AT is the standard grade for moldings of normal wall thickness (> 1.5 mm) and flow paths which are not too long. The free-flowing Ultraform® S2320 003 AT is recommended when the walls are thinner and the flow paths longer.

Ultraform® W2320 003 AT is available when due to the upper processing temperature limit, complete filling of the mold with Ultraform® S2320 003 AT is no longer possible.

The flow characteristics of these grades as a function of the wall thickness as revealed by the spiral flow test are shown in Fig. 25. Although this test is not standardized, it nevertheless allows a practice-based assessment. The flowability or the flow path of a product depends not only on the processing parameters, such as injection pressure, injection speed, melt and mold temperature, but also on the design of the mold and of the machine. Fig. 26 provides an overview of how flow depends on the melt temperature. Despite having good flow properties, Ultraform® injection molding grades do not tend to form flash.

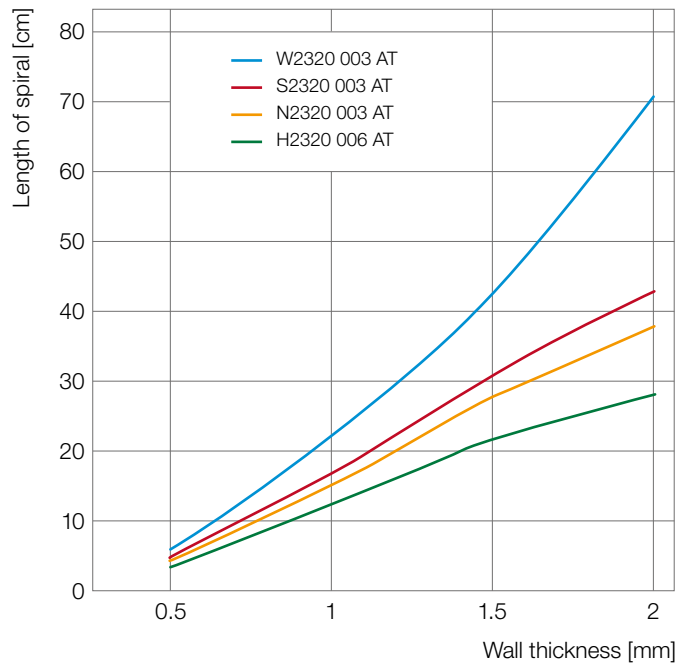

Fig. 25: Flowability as a function of wall thickness (spiral flow test). Screw diameter: 30mm, mold: Flow spiral, injection pressure 1000 bar, melt temperature 200 °C, mold temperature 80 °C

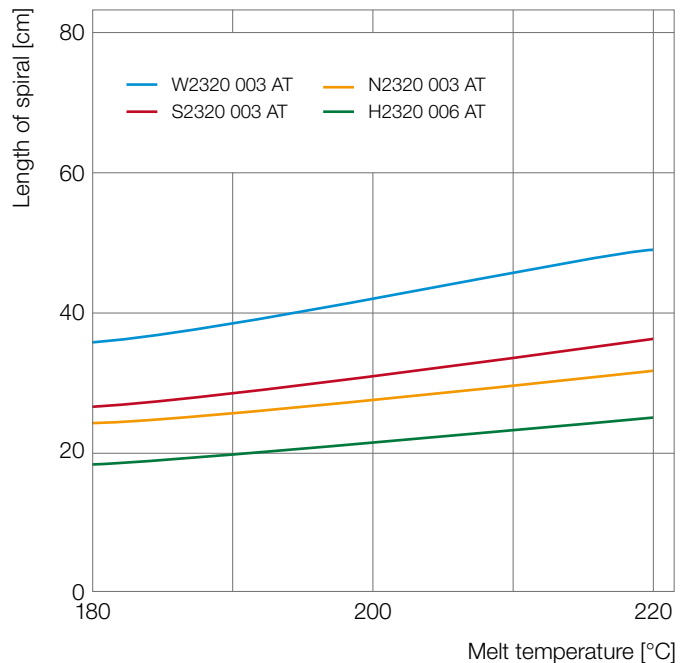

Fig. 26: Flowability as a function of melt temperature. Flow spiral: wall thickness 1.5 mm, cycle time 20s, injection pressure 1000 bar, mold temperature 80 °C

### Processing speed

The determining factors for the cycle time in injection molding are, on the one hand, the time required for the compound to cool from the processing temperature to the demolding temperature and, on the other hand, the solidification rate. In the case of semi-crystalline thermoplastics, the solidification rate is closely coupled to the crystallization rate.

In the case of thin-walled parts the processing speed is mainly determined by the rate of crystallization, while for thick walls it is principally determined by the rate of the plastic's heat conduction.

The Ultraform® grades are characterized by high solidification rates and are therefore exceptionally suitable for the economic production of thin-walled parts.

### Demolding

Ultraform® can be readily demolded. Even with high mold surface temperatures it has no tendency to stick to the mold walls. The draft angles in injection molds are normally 1 to 2 degrees. Smaller drafts are possible for Ultraform® due to the high contraction in volume. However, the ejector must have a large contact area.

The general rule is that the ejector pins should not be too thin relative to the part. Otherwise, the molded parts will be damaged by the indentation of the ejector pins during demolding if the cycle is short or the mold temperature is high.

The mold cooling channels should be designed in such a way that the molding is cooled as uniformly as possible and as a result can solidify largely free of warpage.

### Shrinkage and aftershrinkage

Shrinkage is defined as the difference between the dimensions of the cavity of the mold and those of the molding at room temperature. It is normally determined 24 hours after production and expressed in percent (ISO 294-3/4). As accurate a prediction as possible of the anticipated shrinkage is important, especially for the mold maker.

The dimensions of the mold must be designed in such a way that moldings with the desired final dimensions can be produced. Although shrinkage is primarily a property of the material, it is additionally determined by the shape and wall thickness of the injection-molded part and by the processing conditions (mold surface temperature, melt temperature, holding pressure, injection speed, position, and size of the gate). The interaction of these different factors usually makes it very difficult to predict shrinkage exactly. For the determination of practice-relevant shrinkage dimensions a test box has proven to be useful, as shown in Fig. 27. Usually, the length A is evaluated as the measure of the shrinkage of the bottom of the box.

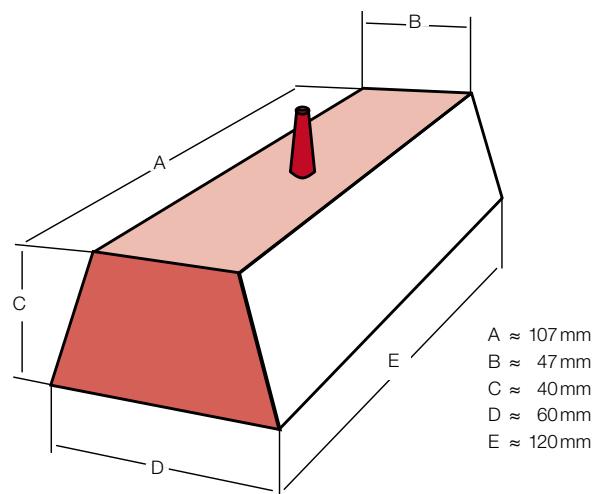

Fig. 27: Test box

The temperature of the mold surface and the wall thickness of the molded part have the greatest influence on shrinkage. Figure 28 shows this dependence with reference to plates (110x110mm) having wall thicknesses of 1 mm, 2 mm and 4 mm. It can be seen that shrinkage increases rapidly as the mold temperature rises. Here the mold temperature is always to be taken as the measured surface temperature and not the temperature of the temperature control medium.

With reference once more to the shrinkage plates, Fig. 29 shows the dependence of shrinkage on holding pressure. Higher holding pressures partially compensate for shrinkage. Other factors, such as the melt temperature or the injection speed, for example, do not affect the shrinkage of Ultraform® to any great extent. It only increases slightly as the melt temperature rises and the injection speed falls.

Over time, the dimensions of injection moldings may alter slightly owing to temperature-dependent and time-dependent post-crystallization and also in small measure to the relaxation of internal stresses and alignments.

Fig. 30 shows the shrinkage measured on the test box after 16-24 hours (Curve 1), 14 days and 60 days (Curves 2 and 3). The parts were stored at room temperature. After-shrinkage, i.e. the increase in shrinkage due to postcrystallization, is visible from the curves. Curve 4 shows the shrinkage of the same parts after 24 hours at a temperature of 120°C.

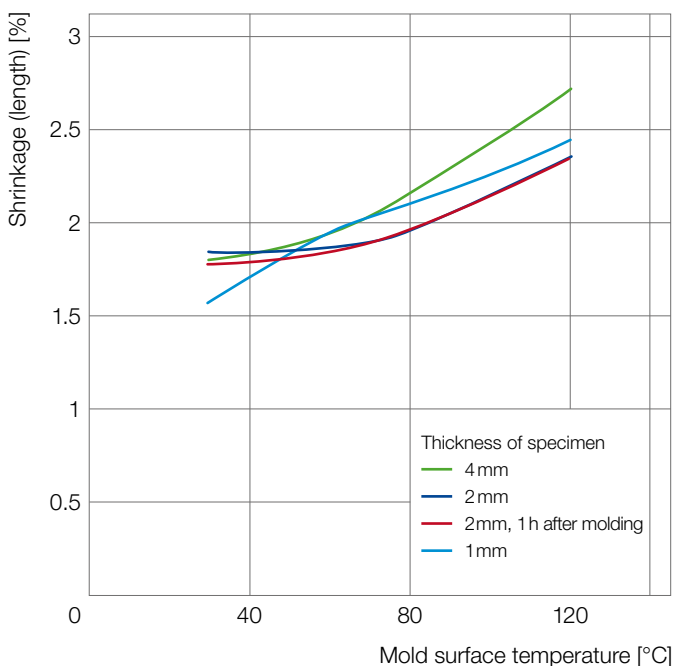

Fig. 28: Shrinkage of plates made of Ultraform® N2320 003 AT UN depending on mold temperature. Holding pressure 500 bar, holding pressure time 15/25 sec, mass temperature 200 °C, measurement 16-24 hours after injection molding or 1 hour after injection molding, measuring points: 30, 60, 90, 120 °C

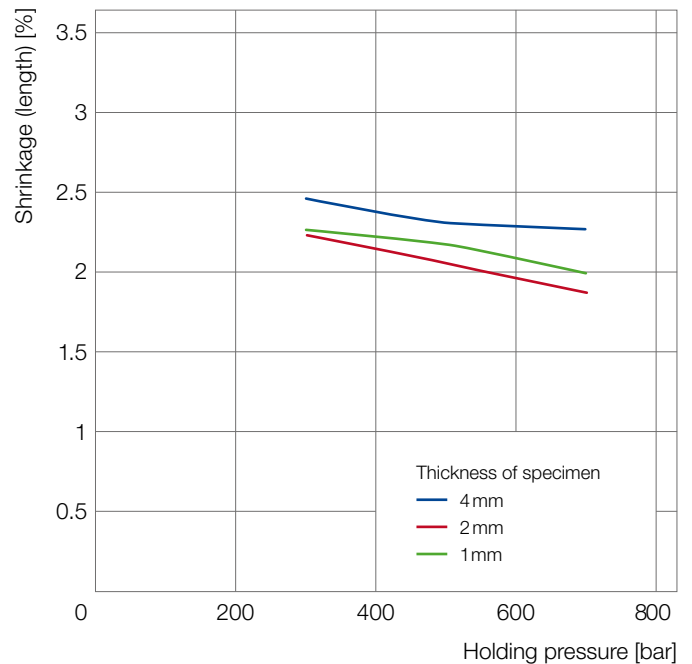

Fig. 29: Shrinkage of plates made of Ultraform® N2320 003 AT UN as a function of holding pressure. Melt temperature 200 °C, mold temperature 90 °C, measurement 22-24 hours after injection molding, cycle time 40-60 seconds, hold time 15/25 seconds

Annealing is worthwhile when injection-molded parts made from Ultraform® are to be exposed to relatively high temperatures in later use. The tempering anticipates the change in dimensions otherwise to be expected as a result of post-crystallization. As Fig. 30 shows, however, tempering can be dispensed with when injection molding is carried out at high mold temperatures.

Shrinkage of the glass-fiber reinforced Ultraform® N2200 G53 AT is substantially smaller than that of the unreinforced grades. However, due to the orientation of the glass fibers, the shrinkage is anisotropic. Depending on the shape, gate position and processing conditions, this can cause warpage of the moldings.

By contrast, the mineral-filled Ultraform® N2720 M63 is largely characterized by isotropic shrinkage. Fig. 31 shows shrinkage parallel and perpendicular to the direction of flow for free shrinkage of unreinforced, glass-fiber reinforced and mineral-filled Ultraform®.

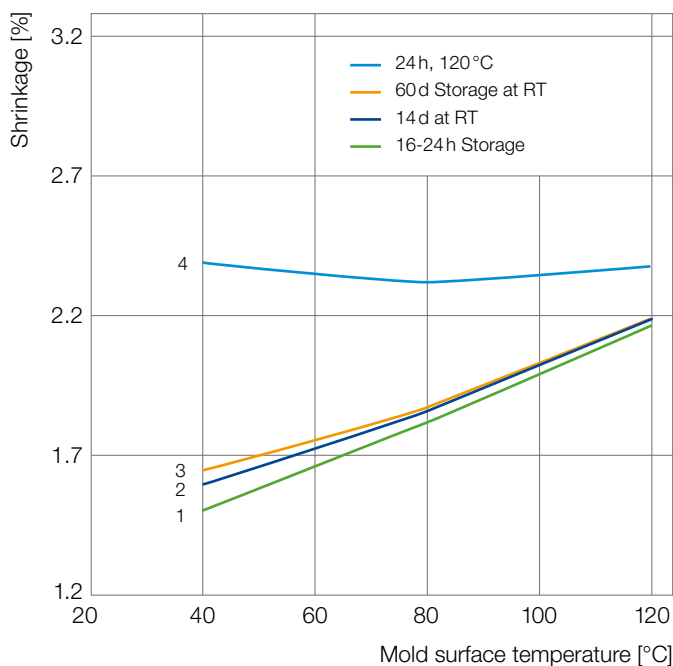

Fig. 30: Shrinkage and after-shrinkage of Ultraform® N2320 003 AT as a function of mold temperature, time, and storage temperature. Mold wall thickness 1.5 mm, melt temperature 210 °C, holding pressure 500 bar, dimension measured A = 107 mm

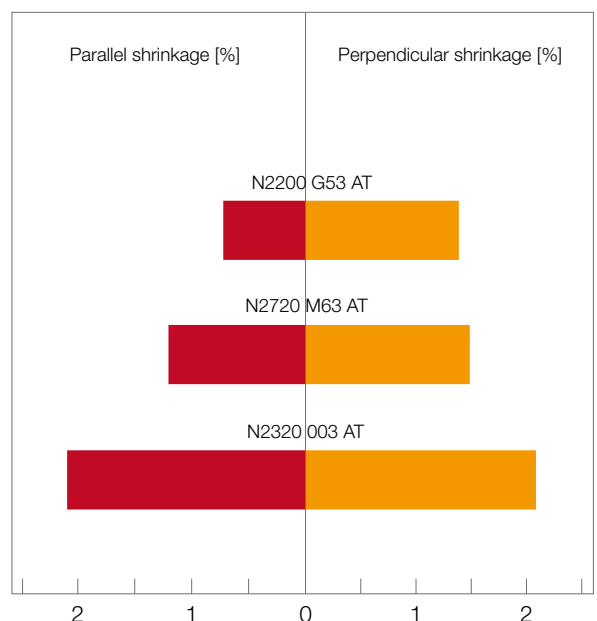

Fig. 31: Shrinkage of unreinforced as well as glass fiber and mineral filled Ultraform® AT parallel and perpendicular to flow direction at free shrinkage, measured on plates 60x60x2 mm acc. ISO 294-4. Melt temperature 200 °C, mold temperature 90 °C

## Fabrication and Finishing Processes

### Machining

Semi-finished parts made from Ultraform® can be machined with all conventional machine tools. Generally, cutting speeds should be high and feed rates low.

### Joining methods

Parts made from Ultraform® can be joined at low cost by a variety of methods. The mechanical properties of Ultraform®, especially its toughness, allow the use of self-tapping screws. Ultraform® parts can be connected without difficulty to one another or to parts made from other materials via rivets and bolts.

Snap-in and press-fit connections can also withstand high stresses. Ultraform®'s outstanding elasticity and strength, even at high temperatures, is particularly suitable for this form of construction.

Ultraform® parts can be welded by heating-element (thermal contact and radiation) methods, and by ultrasonic, vibration and spin welding methods. Only high-frequency welding is not feasible for Ultraform® due to the low dielectric dissipation factor.

The laser irradiation welding method is suitable for combinations of parts molded from Ultraform® which is transparent to laser (e.g. natural-colored) and parts molded from Ultraform® absorbing laser (e.g. black). In this way, very clean welded joints can be produced without flash.

Ultrasonic welding is preferred in cases where short welding times and ready integration into fully automated production flows are required. The strongest welded joints are achieved with the heating-element method.

Apart from the welding method and the welding parameters, the geometry of the mating surfaces is of great importance for the quality of the welded joints. It is therefore advantageous to choose the best method at the design stage and then to design the mating surfaces accordingly.

### Adhesive bonding

In order to activate the non-polar material, it is necessary to pre-treat the surfaces, e.g. by etching, priming or corona discharge.

Adhesive bonding is possible only with pressure-sensitive adhesives. The joint obtained is impervious to gas, air and moisture, but has only low mechanical strength.

Since the pre-treatment, primer and adhesive form a single system, adhesives suppliers or the BASF Application Engineering experts should be contacted to provide help in solving bonding problems.

### Printing, embossing, varnishing and metallization

Ultraform®'s hard, smooth surface and high resistance to chemicals have an adverse effect on the bonding strength of coatings. The usual methods of pre-treating plastics do not afford satisfactory results.

The use of certain printing inks in conjunction with a subsequent, brief flame treatment or with high-temperature aging translates into high adhesive strength without the need for any special pre-treatment. Please consult the BASF Applications Engineering experts for the clarification of any specific questions.

Embossing films are available for hot stamping, which exhibit adequate adhesion even without pre-treatment of the surfaces.



### Electroplating

Surface pre-treatment is necessary for the production of electroplated moldings. Parts made from Ultraform® can be electroplated by the method commonly used for ABS. The first stage in the process, however, etching with chromosulfuric acid, is replaced by acid treatment in dilute sulfuric or nitric acid.

It is imperative that the use of baths containing hydrochloric acid should be avoided.

To remove any superficial acid residues, the parts are then immersed in a weakly alkaline bath and rinsed thoroughly. The rest of the process is as for ABS.

According to cyclical temperature tests in the automotive and sanitary ware industry, this method achieves relatively firm anchorage of the metal layer to the molding.

### Laser marking

Table 4 provides an overview of the suitability of uncolored and black Ultraform® to be marked by various lasers. Nd:YAG lasers with a wavelength of 1064 nm are often employed for printing. In general, black Ultraform® grades – color code “black 11020” in particular – enable high-contrast lettering and images with Nd:YAG lasers.

Laser	Wavelength	Uncolored Ultraform®	Ultraform® black 120
UV	308 nm	–	light marking
UV	355 nm	–	light marking
Nd:YAG “green”	512 nm	–	light marking
Nd:YAG	1064 nm	–	light marking
CO <sub>2</sub>	10.6 μm	engraving	engraving

Table 4: Laser marking performance of Ultraform®

---

# General Information

---

## Safety Notes

### Safety precautions during processing

Ultraform® decomposes when subjected to excessive heat. The decomposition products formed in this case consist essentially of formaldehyde, a gas which has a pungent smell even at very low concentrations and irritates the mucous membranes. Decomposition can rapidly result in the build-up of a high gas pressure in the barrel of the processing unit.

If the die is sealed, there may be a sudden release of pressure via the filling hopper. If the dies and filling opening are blocked, there is a risk that, as a result of the rising gas pressure in the barrel, the bolts between the barrel and the barrel head on the one hand or between the cylinder head and die on the other hand will shear. This could be life-threatening. It is therefore essential to check the correct operation of the measurement and control devices before the processing machine is started up. Fully automatic systems must be capable of early detection and elimination of technical malfunctions in the processing machine.

When Ultraform® is properly processed, usually only very little formaldehyde appears around the processing equipment. In contrast, if the melt is subject to processing at an excessively high temperature and/or a long residence time of in the processing machine, a stronger formaldehyde odor might occur. In case of such an operational malfunction, which is also noticeable in the form of brownish burn streaks on the molded parts, the cylinder of the processing machine should be flushed by spraying the melt outside. At the same time, the barrel temperature must be reduced. Cooling the damaged material in a water bath can prevent nuisances caused by odors.

The implementation of ventilation and exhaust ventilation measures, preferably through the installation of an extraction hood over the barrel unit, is recommended.

Gas sampling devices for monitoring the country-specific occupational exposure limits for formaldehyde are available on the market.

Contamination of Ultraform® by thermoplastics that cause decomposition of polyacetals, e.g. PVC or plastics containing halogenated fire protection agents, must be avoided under all circumstances. Even small quantities can cause uncontrolled and rapid decomposition of the Ultraform® during processing.

Pellets and finished parts must not be allowed to come into contact with strong acids (especially concentrated hydrochloric acid) since they cause Ultraform® to decompose.

### Occupational health and safety

There have been no problems with people who work with Ultraform® when the material has been properly processed and the work areas have been well ventilated.

The country-specific occupational exposure limits for formaldehyde must be observed.

### Food legislation

Regarding their composition, the uncolored standard grades of our Ultraform® product line, such as H2320 006 AT, H4320 AT, N2320 003 AT, N2320 Aqua® AT, S2320 003 AT, S2320 Aqua® AT, and W2320 003 AT, are in compliance with current regulations for food contact in Germany, Europe, and the United States. The conformity of these products is furthermore guaranteed by the production in compliance with the GMP (good manufacturing practice) Food Contact standard. In case of detailed information about the food contact status for a certain standard grade, a colored Ultraform® or a special grade, please contact BASF (plastics.safety@basf.com) directly. We are pleased to send you a food contact compliance letter regarding the regulations in force at present.

### Storage and transportation

Ultraform® is supplied as cylindrical or lenticular granules. The products are normally dried ready for processing and supplied in moisture-tight packaging.

Ultraform® is not classed as hazardous within the meaning of CLP Regulation (EC) no. 1272/2008 and is therefore not considered a dangerous good for transportation. Further information can be found in the product safety data sheets.

Ultraform® is classed as not hazardous to water. Standard packaging is 25 kg bags, 1,000 kg big bags, and 800 kg octabins. All containers are tightly sealed and should not be opened until right before they are used.

Ultraform® is not subject to change when it is stored in dry, ventilated rooms. After relatively long storage (>1 year) or when handling material from previously opened containers, preliminary drying is recommended in order to remove any moisture which has been absorbed. Please follow the instructions for storage given in the product safety data sheet.

### Color

Ultraform® is supplied in both colored and uncolored form. Uncolored Ultraform® has a white-opaque natural color. Several products are available in shades of black. Individual grades can be supplied in a variety of shades upon request.

### Disposal

All Ultraform® grades can be incinerated in accordance with official regulations. The calorific value of unreinforced grades is 29,000 to 32,000 kJ/kg ( $H_u$  according to DIN 51900).

### Recovery

Waste materials, e.g. Ultraform® moldings and sprue, can be recycled provided the polymer is clean and has not been thermally degraded. After relatively long storage, the ground material should be dried before being returned to reprocessing. The maximum permissible proportion of ground material depends on the dimensional and mechanical requirements imposed on the moldings and must be determined in trials. More details can be found in the 'Reprocessing' section.

## (Integrated) Management System

### QHSE management

Quality, environment, and energy management are key elements of BASF's corporate policy. Customer satisfaction is a significant target. The ongoing improvement of our products and services in terms of quality, environment, safety, and health, is our primary goal.

The BASF business unit Performance Materials uses an integrated management system that covers issues such as quality, environment (including energy), Responsible Care®, safety, and health.

The business unit is recognized by an accredited certification company for its:

- Quality Management System according to ISO 9001 and ISO TS IATF 16949
- Environment Management System according to ISO 14001
- Energy Management System according to ISO 50001

## Nomenclature

### Structure

The name of Ultraform® commercial products generally follows the scheme below:



### Technical ID

The technical ID is made up of a series of letters and numbers indicating the melt flow rate, the type of reinforcing agents, fillers, modifiers or additives used, their content in the material, and special features where applicable.

The following system is used for most products:

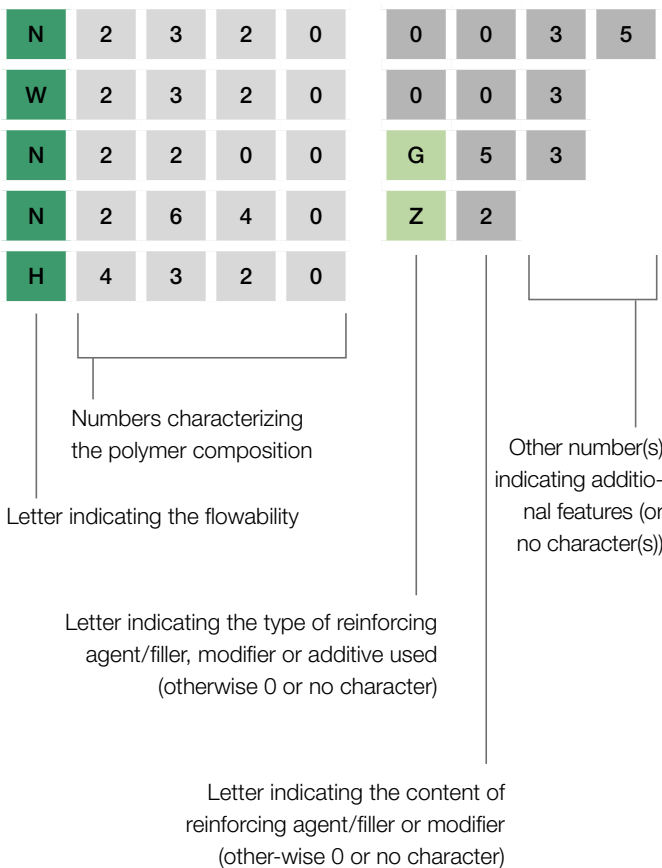

### Letters indicating the melt flow rate

The melt flow rate corresponds to the position of the letter in the alphabet: the later the letter appears in the alphabet, the higher the melt flow rate. The letters H, N, S and W are most commonly used. The following applies:

- H Lowest flow rate, lowest MVR value
- W Highest flow rate, highest MVR value

### Letters indicating the type of reinforcing agent, filler, modifier or additive used

- G Glass fibers
- K Chalk
- M Mineral
- P Specialty lubricant
- U UV-stabilized
- Z TPU impact modified

### Indices describing the content of reinforcing agents, fillers or modifiers

The numbers 2, 4, 5, 6 and 9 are most commonly used. The higher the number, the higher the content.

The following rule of thumb applies:

- 2 approx. 10% by mass
- 4 approx. 20% by mass
- 5 approx. 25% by mass
- 6 approx. 30% by mass
- 9 approx. 45% by mass

### Suffixes

Suffixes are optionally used to indicate specific processing or application-related properties. They are frequently acronyms whose letters are derived from the English term.

#### Examples of suffixes:

- Aqua® Meets specific regulatory requirements for drinking water applications
- BMB Bio Mass Balanced
- LEV Low emission version; low-odor
- LowPCF Low Product Carbon Footprint
- PRO Profile covered raw materials only; meets specific regulatory requirements and needs for medical applications
- TR Tribological modified

### Color

The color is generally made up of a color name and a color number.

#### Examples of colors:

- Uncolored
- Black 00120
- Black 00140 (for products modified with thermoplastic polyurethane)

## Subject Index

**Adhesive bonding** 32  
After-shrinkage 29 ff.  
Automotive applications 4 f.

**Bearing** 8  
Behavior on exposure to  
– light 17  
– weather 17  
– high-energy radiation 20  
Behavior under  
– long-term static loading 11 f.  
– cyclic loads 14  
– flexural fatigue strength 14

**Color** 35  
Compatibility with other thermoplastics 23  
Conveyor belt part 14

**Demolding** 29  
Disposal 35  
Drainage tube 6  
Drug delivery devices 9

**Electrical properties** 20  
Electroplating 33  
Energy Management 35  
Embossing 32  
Environmental management 35  
Everyday applications 6 f.  
Extrusion grades 20

**Fabrication** 32 f.  
Feed characteristics 27  
Finishing processes 32 f.  
Fire behavior 20  
Flow characteristics 28  
Food legislation 35

**Gas meter housing** 7  
Gate design 25  
General notes 22  
General information 34 ff.  
Grades with special treatment 21

**Injection molding** 24  
Injection-molding grades  
– impact-modified 21  
– mineral-filled 21  
– standard 21  
– glass fiber-reinforced 21  
– tribological 21  
Injection mold 25  
Injection nozzle 24  
Injection unit 24  
Insulin pen 9  
Impact strength 12 f.  
Implantation aid 9  
Industrial applications 8

**Joining methods** 32

**Laser marking** 33  
Liquid trap 5

**Machining** 32  
Management system 35  
Mechanical properties 10 ff.  
Medical applications 9  
Metal inserts 25  
Metallization 32  
Mirror actuator 5  
Mold design 25  
Mold filling 27  
Mold temperature control 26

**Nomenclature** 36  
Non-return valve 24  
Nozzle outlet 6

**Occupational health** 34  
Occupational safety 34

**Pipe connector** 7  
Plastic bearing with integrated  
– gear teeth for ATM 8  
– features for steering column 8  
Preliminary treatment 22  
Printing 32

**P**rocessing 22 ff.  
Processing by injection molding 26 ff.  
Processing speed 29  
Processing temperature 26 f.  
Product line 20 f.  
Properties 10 ff.  
Protection against wear 24

**Q**uality management 35

**R**ecovery 35  
Re-processing 23  
Resistance to  
– chemicals 18 f.  
– fuels 18 f.  
– water 18 f.

**S**afety notes 34  
Safety precautions 34  
Seatbelt clip 5  
Self-coloring 22  
Shrinkage 29 ff.  
Shutdown 22  
Skate wheel 8  
Skin stretcher 9  
Speaker grills 5  
Spring clip 7  
Start-up 22  
Sterilization 19  
Storage 35

**T**hermal properties 16  
Three-section screw 24  
Transportation 35  
Toilet flush 7  
Tribological properties 14 f.

**V**arnishing 32



## Selected Product Literature for Ultraform®:

- Ultraform® – Product Brochure
- Ultraform® – Product Range
- Ultramid®, Ultradur® and Ultraform® – Resistance to Chemicals
- Engineering Plastics for Medical Solutions – Ultraform® PRO (POM) and Ultradur® PRO (PBT)
- Ultraform® Sustainable Solutions for a Better Future

### Note

The data contained in this publication is based on our current knowledge and experience. Considering the many factors that may affect processing and application of our product, these data do not relieve processors from carrying out their own investigations and tests; neither do these data imply any guarantee of certain properties, nor the suitability of the product for a specific purpose. Any descriptions, drawings, photographs, data, proportions, weights etc. given herein may change without prior information and do not constitute the agreed contractual quality of the product. It is the responsibility of the recipient of our products to ensure that any proprietary rights and existing laws and legislation are observed. (June 2023)

Further information on Ultraform® can be found on the internet:

[www.ultraform.basf.com](http://www.ultraform.basf.com)

Please visit our website:

[www.plastics.basf.com](http://www.plastics.basf.com)

If you have any technical questions about the products, please contact our Ultra-Infopoints:

#### EMEA Infopoint



#### North America Infopoint

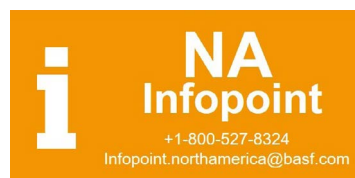

#### Asia Pacific Infopoint

