

Ultradur® (PBT)

Product Brochure

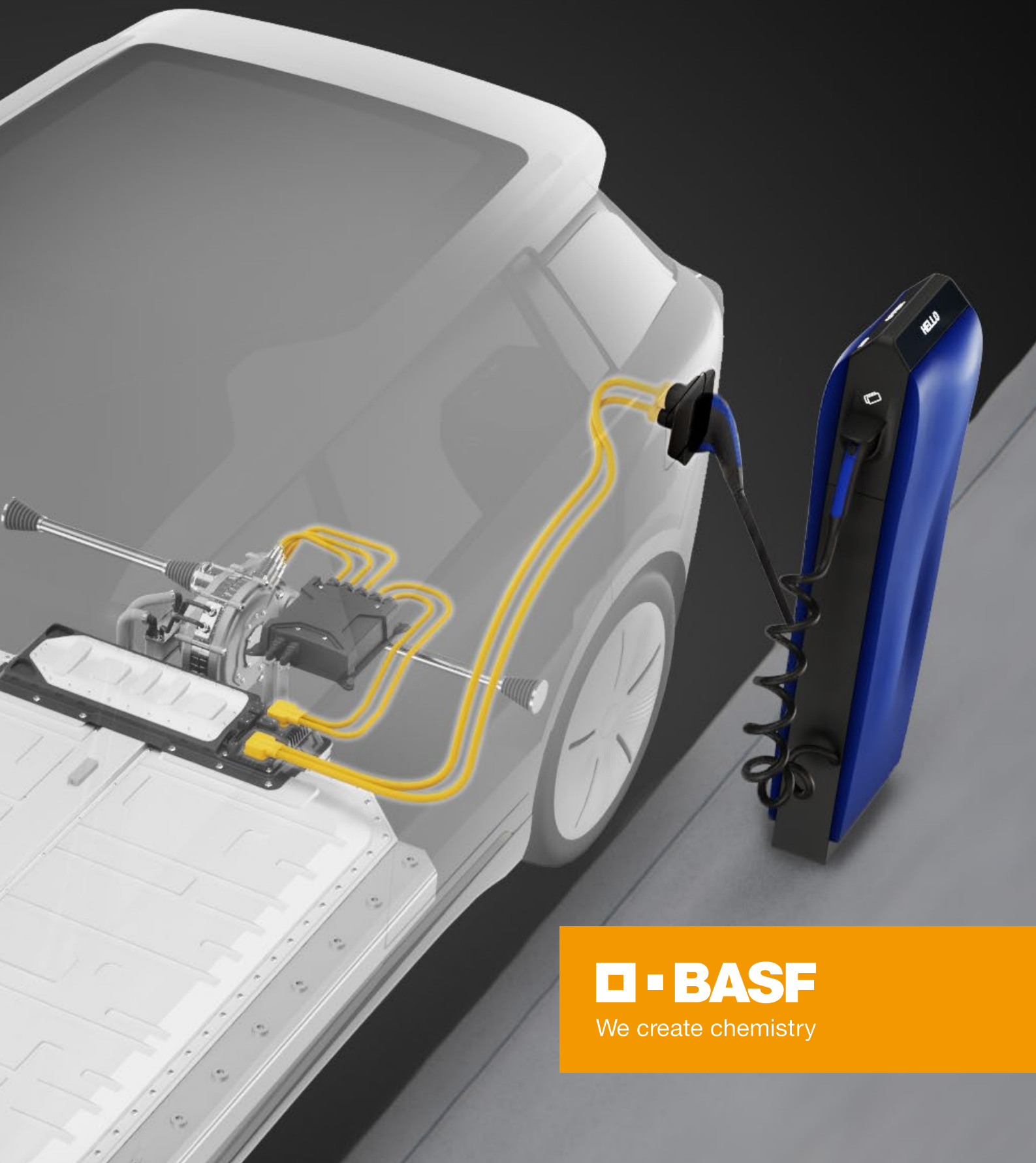

 **BASF**

We create chemistry

Ultradur® (PBT)

Ultradur® is BASF's trade name for its line of partially crystalline saturated polyesters. This line is based on polybutylene terephthalate and is employed in applications demanding a high performance level such as load bearing parts in different industrial sectors. Ultradur® is outstanding for its high rigidity and strength, very good dimensional stability, low water absorption, good electrical properties and high resistance to many chemicals. Moreover, Ultradur® exhibits exceptional resistance to weathering and excellent heat aging behavior.

Ultradur® (PBT)

ULTRADUR® IN AUTOMOTIVE ENGINEERING		4-5
ULTRADUR® IN ELECTRICAL ENGINEERING AND ELECTRONICS		6-7
ULTRADUR® IN INDUSTRIAL AND HOUSEHOLD APPLICATIONS		8-9
THE PROPERTIES OF ULTRADUR®		10-25
	Product range	10
	Mechanical properties	14
	Tribological properties	19
	Thermal properties	20
	Electrical properties	22
	Fire behavior	23
	Resistance to chemicals and behavior on exposure to weather	24
THE PROCESSING OF ULTRADUR®		26-39
	General notes	26
	Injection molding	28
	Extrusion	34
	Fabrication and finishing processes	38
GENERAL INFORMATION		40-46
	Safety notes	40
	Delivery and storage	40
	(Integrated) management system	41
	Nomenclature	42
	Subject index	44

Ultradur® in automotive engineering

Ultradur® shows its strengths wherever high-quality and above all heavy-duty parts are required – for example in the automotive industry. Ultradur® is rigid, impact resistant, dimensionally stable, heat and weather resistant as well as resistant to fuels and lubricants. It shows an excellent electrical and thermal long term behavior – all properties that have made Ultradur® an indispensable material in many applications in modern automotive engineering.

Ultradur® is used in windscreen wiper arms, door handles, headlamp structures, mirror systems, connectors, sun-roof components, in housings for locking systems, in roof rack supports, hinge arms and in many other applications.

A feature that is particularly important for automotive electronics is the low water absorption and thus the fact that the mechanical and electrical properties are largely independent of the moisture content or the climatic conditions of use. Particularly for components that have an impact on safety and have to work reliably for the entire lifetime of a car, Ultradur® is indispensable. The range of applications in automotive electrics includes plug-in connectors, sensors, drives and the full range of control units including the safety-relevant ABS/ESP systems, airbag control units, or electric steering systems.



Mirror actuator housing



Windscreen wiper arm



Rain sensor



Mirror arm



Headlamp housing

Ultradur® in electrical engineering and electronics

Wherever electricity flows, plastics need to have excellent electrical properties, good mechanical values and a high level of dimensional stability under heat. In daily operation, they ensure electrical insulation and thus protection if they are touched. Thanks to its special combination of properties, Ultradur® is an ideal material for many applications in the field of electrical engineering and electronics. As well as showing outstanding dimensional stability and excellent long-term electrical and thermal performance, it can be modified in versatile ways, e.g. with regard to enhanced flowability, strong hydrolysis resistance, low warpage, excellent laser-welding and laser-markable properties, as well as very good flame-retardant characteristics.

Ultradur® is used among other things for electrical installations in railway cars, circuit breakers, plug-in connectors and electronic switching elements for increased voltages (e.g. railway cars, alternative drives, photovoltaic installations).



Connectors

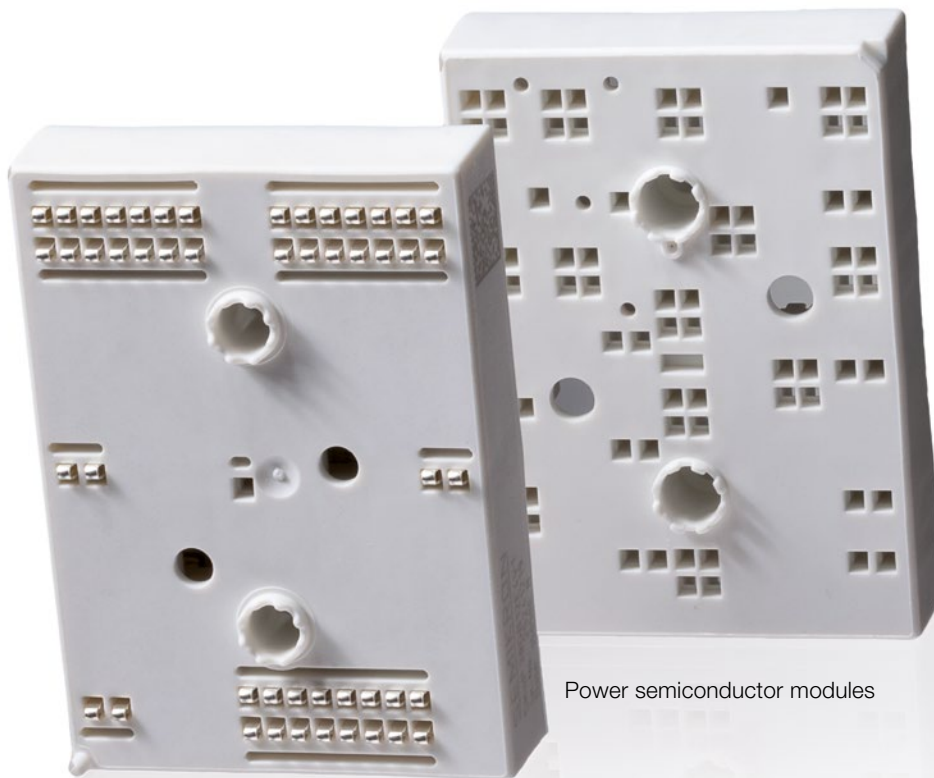

Power semiconductor modules



ABS/ESP steering sensor



Connector



Safety switch housing



Motor circuit breaker

Ultradur® in industrial and household applications

The high rigidity, strength and outstanding dimensional stability of Ultradur® remain comparatively unaffected by external factors such as humidity.

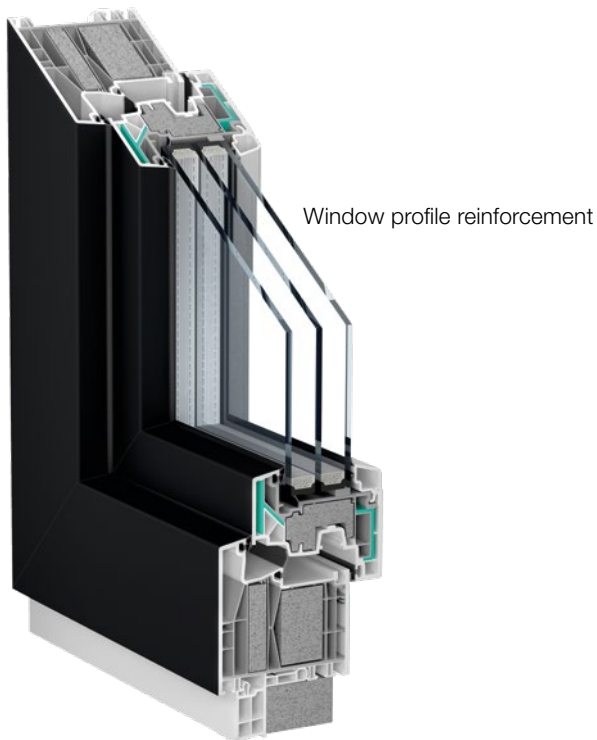

The range of applications which benefit from these properties of Ultradur® in both industry and everyday life is vast and comprises:

- Packaging, e.g. films or paper coatings; food contact grades for single-layered packaging to seal in the aroma, e.g. in coffee capsules or sauce cups
- fibers for bristles, screen meshes, or nonwovens
- toys with correspondingly high requirements on the plastic's safety
- masterbatches as additives for thermoplastics
- sanitary products and applications for irrigation technology
- metal replacement in window profiles for boosting energy efficiency
- Components of household appliances such as refrigerators, ovens and coffee machines
- Mechanical, functional parts or components for medical applications, e.g. adjusting scales, protective covers, couplings and push buttons for drug release systems, such as insulin pens, inhalers and auto injectors

These products also benefit among other things from the excellent sterilization, high surface quality, compliance with food safety regulations, and the approval for the drinking water sector of the corresponding Ultradur® grades.



Coffee capsules



Sauce tubs



Insulin pen

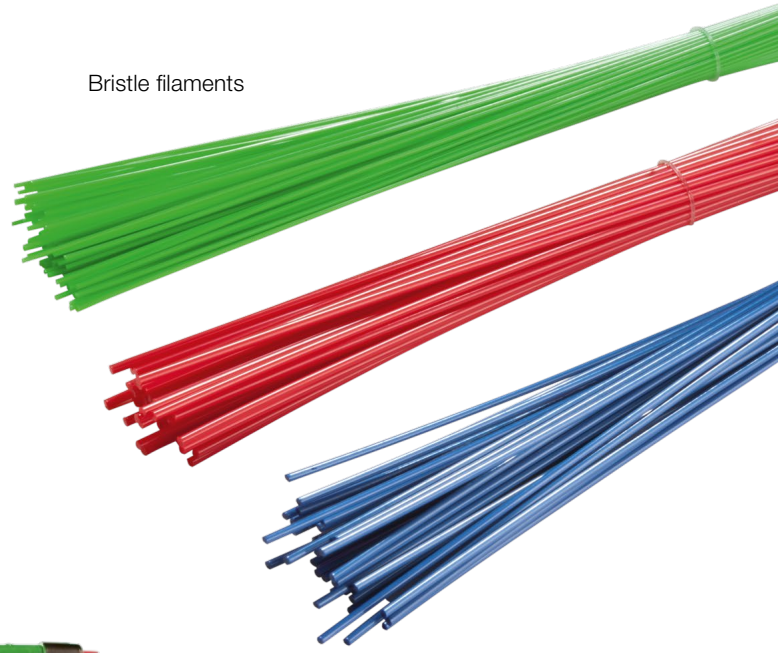

Bristle filaments



Toy



Film



Compressor

The properties of Ultradur®

The Ultradur® grades are polyalkylene terephthalate molding compounds based on polybutylene terephthalate. The chemical structure is illustrated in the following structural formula:

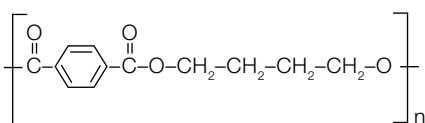

Ultradur® is produced by polycondensation of terephthalic acid or dimethyl terephthalate with 1,4-butanediol using special catalysts. Terephthalic acid, dimethyl terephthalate and 1,4-butanediol are obtained from petrochemical feedstocks, such as xylene and acetylene.

Product range

The most important applications of Ultradur® are automotive engineering, electrical engineering, electronics and telecommunications as well as precision engineering and general mechanical engineering. For these applications, a variety of Ultradur® types is available. When selecting the most suitable types for your specific purpose our technical support will be glad to help.

Unreinforced grades

The Ultradur® range includes a variety of PBT grades which differ in their flow properties, demolding and setting behavior. The unreinforced grades are used for parts with very good surface quality, with applications ranging from packaging film to filigree connectors in electrical engineering and functional parts such as gear wheels.

Reinforced grades

Ultradur® demonstrates the full potential of its positive properties in a wide range of glass-fiber reinforced grades. Ultradur® types with different glass-fiber contents are available on demand as standard, including types with a glass-fiber content of over 50%. Processed to molded parts, these Ultradur® grades are key players in assemblies that withstand high mechanical stress even at elevated temperatures, such as in the engine compartment of cars.

In addition to the pure PBT/glass-fiber compounds, the range of reinforced grades also includes glass-fiber reinforced PBT blends which have been further optimized with regard to surface quality and dimensional stability. Well-known manufacturers of electronic assemblies have confidence in the reinforced Ultradur® grades as a housing material because of its outstanding performance profile and high consistency of product quality.

Reinforced Ultradur® grades with enhanced flow properties

With the innovative Ultradur® High Speed grades, it is possible not only to fill intricate molds, but also to significantly reduce cycle times compared with standard materials. These particularly economic Ultradur® High Speed grades have different glass-fiber contents and are also available as PBT/ASA blends, the S 4090 grades.

Reinforced Ultradur® grades with particularly low warpage

Manufacturing large, dimensionally stable parts, e.g. ventilation grids in cars, is a major challenge for plastic processors. The warpage-reduced grades make processing easier. These materials have lower contents of anisotropic fillers and reinforcing materials. At special settings, it is possible to achieve roughly equal processing rates in longitudinal and transverse direction – the best conditions for the production of visible low-warpage parts.

Reinforced Ultradur® grades with particularly good hydrolysis resistance

Special additives make the robust Ultradur® even more resistant if it is exposed to water or moisture at elevated temperatures. It was possible to show in various test systems that these specialty grades are resistant to hydrolytic attack for much longer than standard PBT. Further information on Ultradur® HR can be found in the brochure “Ultradur® HR – PBT for hot-damp environments”.

Reinforced Ultradur® grades with outstanding laser transparency

In principle, laser welding of partially crystalline thermoplastics is more difficult than that of amorphous plastics as the laser beam is scattered on the spherulites. This problem, which is shared by all partially crystalline plastics, was particularly pronounced with PBT: Ultradur® LUX now provides a partially crystalline PBT with optical properties that have never been reached before. In comparison with conventional PBT, Ultradur® LUX lets through much more laser light; the widening of the beam is much lower.

The improved laser transparency means that considerably higher welding speeds are now possible, and at the same time the process window is much wider. Thicker components for joining can also be welded than was previously the case. This gives access to applications that were previously reserved for other joining methods. More detailed information about Ultradur® LUX can be found in the brochure “Ultradur® LUX – PBT for laser welding”.

Flame-retardant grades

Many flame-retardant grades are available in the product range. Ultradur® for applications in the construction and electrical appliances sectors, which place special requirements on PBT's flammability. The standard fire-retardant grades are unreinforced and available with 10 to 30 percent glass-fiber reinforcement.

Ultradur® for applications in contact with food and drinking water

Under the name suffix Aqua®, Ultradur® grades are available that have different country-specific approvals for drinking water contact applications. All plastics of the Aqua®-portfolio have at least one approval according to KTW¹⁾, ACS²⁾ and WRAS³⁾ in cold water applications, a large proportion of them also for warm and hot water. To facilitate the approval of finished components, BASF provides all the necessary declarations of conformity and test certificates for Germany and the United Kingdom. If approvals are required from the certification bodies for drinking water and NSF⁴⁾ or other institutes are required, BASF can help by providing the institutes with formulation disclosures. For questions regarding compliance with other regulations and for declarations of conformity please contact your local BASF representative or Plastics Safety (plastics.safety@basf.com).

Ultradur® for medical applications

Ultradur® B 4521 PRO is suitable in particular for injection molding applications in the medical sector. It is noted for its low warpage and shrinkage behavior. This means that Ultradur® B 4521 PRO is able to meet the strict requirements placed on medical components in terms of dimensional stability. Other advantages that are significant for use in medical equipment include the low water absorption and the excellent resistance to many chemicals that are used in the medical sector.

Among other things, gamma rays or ethylene oxide are used for sterilizing the components. More detailed information about Ultradur® PRO can be found in the brochure entitled “Engineering plastics for medical solutions – Ultraform® PRO and Ultradur® PRO”.



¹⁾ KTW: Contact with drinking water (Germany)

²⁾ ACS: Attestation de Conformite Sanitaire (France)

³⁾ WRAS: Water Regulation Advisory Scheme (UK)

⁴⁾ NSF: National Sanitation Foundation (USA)

Unreinforced grades

B 1520 FC R01	Very easy-flowing injection-molding grade for thin-walled packaging with food contact.
B 2550/B 2550 FC	Easy-flowing grade for coating paper and board with high heat resistance, for example for packaging of frozen goods and ready-prepared meals. Also suitable for injection-molding applications with demands on the flowability and for the manufacture of fibers in the spinning process.
B 4500/B 4500 FC B 4520/ B 4520 FC Aqua®	Medium-viscosity grade for manufacturing thin-walled profiles and pipes. The grade is also suitable for the manufacture of industrial functional parts in injection-molding.
B 6550 /B 6550 FC B 6550 L /B 6550 LN B 6551 LNI R01/ B 6550 LNX B 6554 LNI/ B 6560 M2 FC TF	Highly viscous brands for the extrusion of sheaths for optical fibers as well as of sheets, semifinished products for machining production, profiles, tubes and film for deep drawing.
B 4560	Medium viscosity injection-molding grade with good processability for technical components in the automotive sector, such as headlamp housings. Suitable for direct metallizing.

Reinforced grades

B 4300 G2/G4/G6/G10	Injection-molding grades with 10 % to 50 % glass fibers, for industrial parts, rigid, tough and dimensionally stable, for example for thermostat parts, small-motor housings for vehicles, headlamp frames, cams, windshield wiper arms, plug-in connectors, housings, consoles, contact mounts and covers.
B 4300 C3	Injection-molding grade with 15 % carbon fiber content, for technical components, durably antistatic, electrically conductive, e. g. for components of measurement and control devices, components in explosion-proof areas, automotive sensors.
B 4040 G4/G6/G10	Injection-molding grades with 10 % to 50 % glass fibers for industrial parts with excellent surface quality, for example for door handles in vehicles, sunroof frames, oven door handles, toaster casings, exterior mirrors, rear screen wiper arms in vehicles and sunroof wind deflectors.
B 4040 G11 HMG HP	Extrusion type with lower melting point for co-extrusion with PVC, ASA, ABS, PC or PMMA, suitable for PVC window, freezer or other profiles.
S 4090 G2/G4/G6	Low-warpage, easy flowing injection-molding grades with 10 % to 30 % glass fibers for industrial parts with high dimensional stability requirements, for example for plug-in connectors and housings.
S 4090 GX/G4X/G6X	Low-warpage, easy-flowing injection-molding grades with very good processing properties, with 14 % to 30 % glass fibers, for industrial parts with high dimensional stability requirements, for example for internal applications for vehicles, plug-in connectors and housings.

Grades with excellent flowability

B 4520 High Speed B 4300 G2/G3/ G4/G6 High Speed	Easy-flowing injection-molding grades with 10 % to 30 % glass fibers, for industrial parts, rigid, tough and dimensionally stable, for example for housings, consoles, plug-in connectors, contact carriers and covers.
B 4040 G6 High Speed	Easy-flowing injection-molding grade with 30 % glass fibers for industrial parts with excellent surface quality, for example door handles in vehicles, sunroof frames, exterior mirrors and windshield wiper arms.
S 4090 G4/G6 High Speed	Low-warpage, easy-flowing injection-molding grades with 20 % or 30 % glass fibers for industrial parts with high dimensional stability requirements, for example for internal applications for vehicles, plug-in connectors and housings.

Reinforced grades with low warpage

B 4300 K4/K6	Injection-molding grades with 20 % to 30 % glass beads for industrial parts with low warpage, for example precision parts for optical instruments, chassis, housings (including gas meter housings).
B 4300 M2 /M5	Mineral-reinforced, impact-modified injection-molding grades for rigid parts with good surface quality and low warpage, for example central automotive door locks, housings and visible parts of domestic appliances.
B 4300 GM42	Mixed glass-fiber reinforced and mineral-reinforced injection-molding grade with good surface quality and rigidity and with low warpage for parts such as housings and printed circuit boards.

Flame-retardant grades

B 4406 unverstärkt B 4406 G2/G4/G6	Flame-retardant injection-molding grades, unreinforced or with 10 % to 30 % glass fibers, for parts requiring enhanced flame-retardance, for example plug-in connectors and housings, coil formers and lighting components.
B 4406 G6 High Speed	Easy-flowing injection-molding grade with 30 % glass-fiber content, with flame-retardant properties, for components that require enhanced flame-retardance, e.g. plug-in connectors and housings, coil formers and lighting components.
B 4441 G5	Halogen-free flame-retardant injection-molding grade with 25 % of glass fibers for parts requiring enhanced flame-retardance. Specially optimized for the filament requirements of IEC 60335 for increased tracking resistance, for example for plug-in connectors, switch parts and housings for domestic appliances.
B 4450 G5	Halogen-free flame-retardant injection-molding grade with 25 % glass fibers for parts requiring enhanced flame-retardance as well as maximum tracking resistance, for example for plug-in connectors, switch parts or housings for power electronics.
B 4450 G5 HR	Halogen-free flame-retardant injection-molding grade with 25 % glass fibers for parts requiring enhanced flame-retardance as well as maximum tracking resistance and additionally meeting the requirements in terms of hydrolysis stability.
B 4440 unreinforced B 4440 G2	Flame-retardant injection-molding grades, unreinforced or with 10 to 20 % glass fibers for parts requiring enhanced flame-retardance, for example plug-in connectors and housings, coil formers and lighting components.

Reinforced grades with outstanding hydrolysis resistance

B 4330 G3/G6 HR	Impact-modified injection-molding grade with 15 % or 30 % glass fibers, for industrial parts with increased demands on the hydrolysis stability, increased resistance to alkaline solutions and toughness, for example for housings and plug-in connectors in the engine compartment.
B 4300 G6 HR LT	Injection-molding grade with 30 % glass fibers, for industrial parts with increased demands on the hydrolysis stability, for example for housings and plug-in connectors in the engine compartment. Laser-weldable grades with 20 % or 30 % glass fibers; specified transparency for radiation in the near infrared area (800-1100 nm), e.g. of Nd:YAG or diode lasers.
B 4330 G3 HR High Speed	Easy-flowing injection-molding grade with 15 % glass-fiber content, impact-modified, for technical components with increased hydrolysis-stability requirements, e.g. in housings and plug-in connectors in the engine compartment.
B 4300 G6 HR FC Aqua	Injection molding brand with 30 % glass fiber content, for technical parts with increased requirements for hydrolysis stability combined with suitability for use in drinking water and the food sector, e.g. use in household appliances and technology or shower heads.

Reinforced grades with particularly high laser transparency for laser welding

LUX B 4300 G4/G6	Highly laser-weldable grades with 20 % or 30 % glass fibers; particularly high specified transparency for radiation in the near infrared area (800-1100 nm), e.g. of Nd:YAG or diode lasers.
------------------	--

Grades with special properties

LS	Laser-markable products; can be marked with a Nd:YAG laser (1064 nm).
LT	Laser-transparent grades with specified laser transparency; for radiation in the near infrared area (800-1100 nm), e.g. of Nd:YAG or diode lasers.
FC/FC Aqua®	Products suitable for use in drinking water and/or food contact. They meet the regulatory requirements for the corresponding areas of use.
PRO	Products which meet the regulatory requirements in particular in the area of medical devices, such as insulin pens or inhalers.

Table1: Ultradur® Product range

We also offer further products with special properties or for special applications. For more information on products with a special finish, please contact the Ultra-Infopoint.

Mechanical properties

The Ultradur® product range includes grades with various mechanical properties such as rigidity, strength and impact-resistance.

Ultradur® is distinguished by a balanced combination of rigidity and strength with good impact-resistance, thermo-stability, sliding friction properties and excellent dimensional stability.

The strength and rigidity of glass-fiber reinforced Ultradur® grades are substantially higher than those of the unreinforced Ultradur® grades. Figure 1 shows the dependence of the modulus of elasticity and the elongation on the glass-fiber content.

The shear modulus and damping values (Fig. 2) measured in torsion pendulum tests in accordance with ISO 6721-2 as a function of temperature provide useful insight into the temperature-dependence of the properties of the reinforced Ultradur® grades.

The pronounced maximum in the logarithmic decrement at +50°C identifies the softening range of the amorphous fractions while the crystalline fractions soften only above +220°C and thus ensure dimensional stability and strength over a wide range of temperature.

The good strength characteristics of the Ultradur® grades permit high mechanical loads even at elevated temperatures (Figs. 3 and 4).

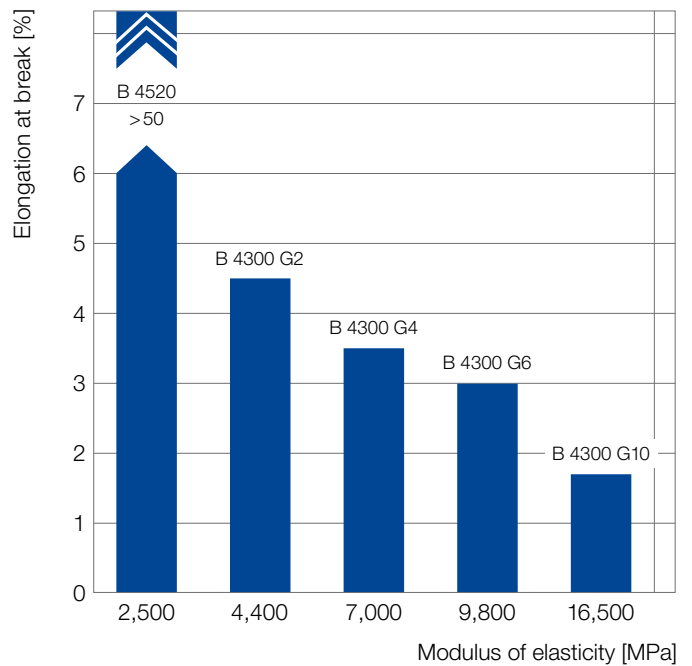

Fig. 1: Modulus of elasticity and elongation at break

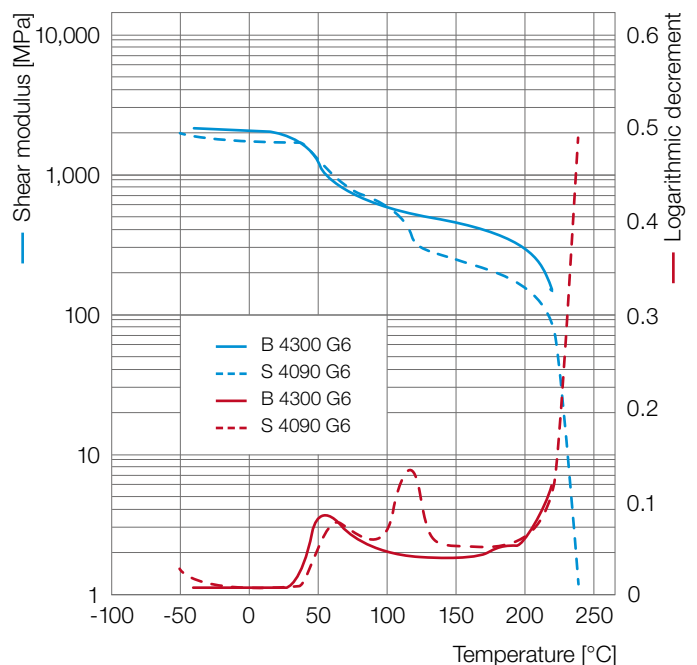

Fig. 2: Shear modulus and logarithmic decrement of glass-fiber reinforced Ultradur® as a function of temperature (in accordance with ISO 6721-2)

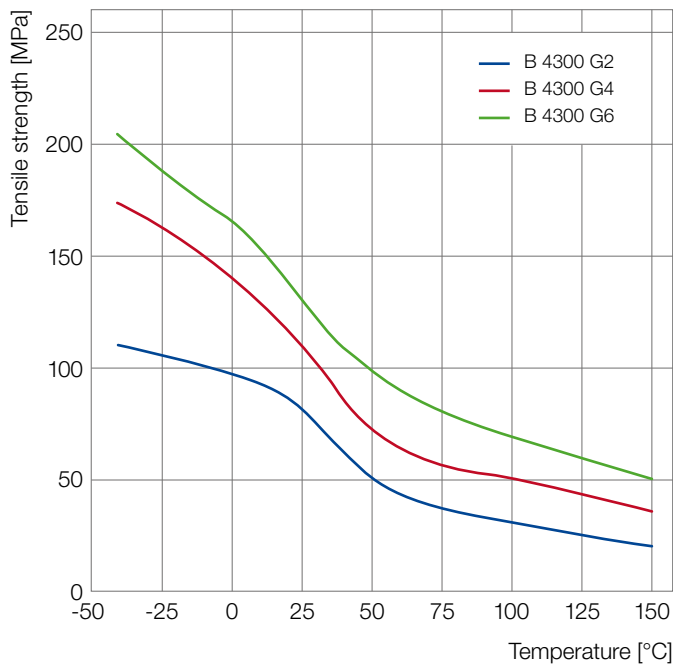

Fig. 3: Tensile strength of glass-fiber reinforced Ultradur® B as a function of temperature (in accordance with ISO 527, take-off speed 5 mm/min)

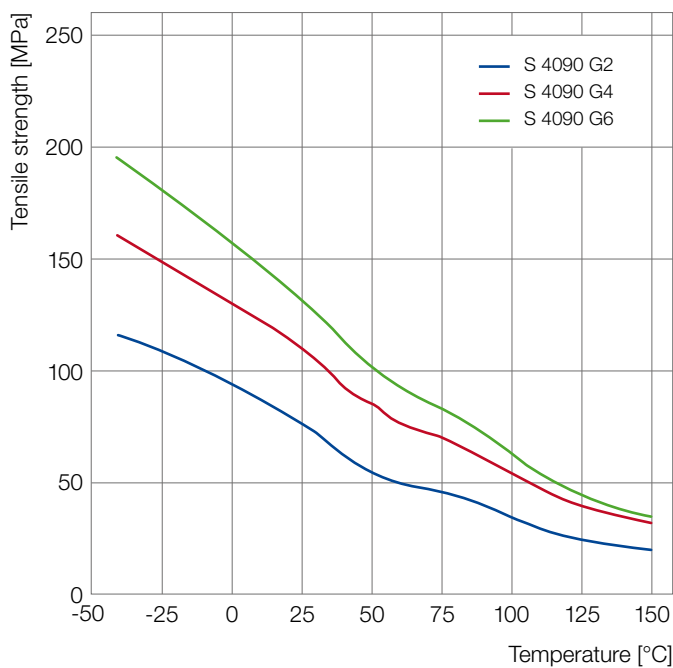

Fig. 4: Tensile strength of glass-fiber reinforced Ultradur® S as a function of temperature (in accordance with ISO 527, take-off speed 5 mm/min)



Air pressure sensor

The behavior under short, uniaxial tensile loads is demonstrated by stress-strain diagrams. Figure 5 shows the stress-strain diagram for unreinforced Ultradur® B 4520 and Figure 6 shows that for Ultradur® B 4300 G6 with 30% glass fibers as a function of temperature.

Toughness, impact strength and low-temperature impact resistance

Impact strength may be specified, for example from the stress-strain diagram, as the deformation energy at failure (Figs. 5 and 6).

A further criterion for toughness is the impact resistance of unnotched test rods in accordance with ISO 179/1eU. According to Table 2 the impact resistance of unreinforced Ultradur® B 4520 is higher than that of glass-fiber reinforced Ultradur® grades.

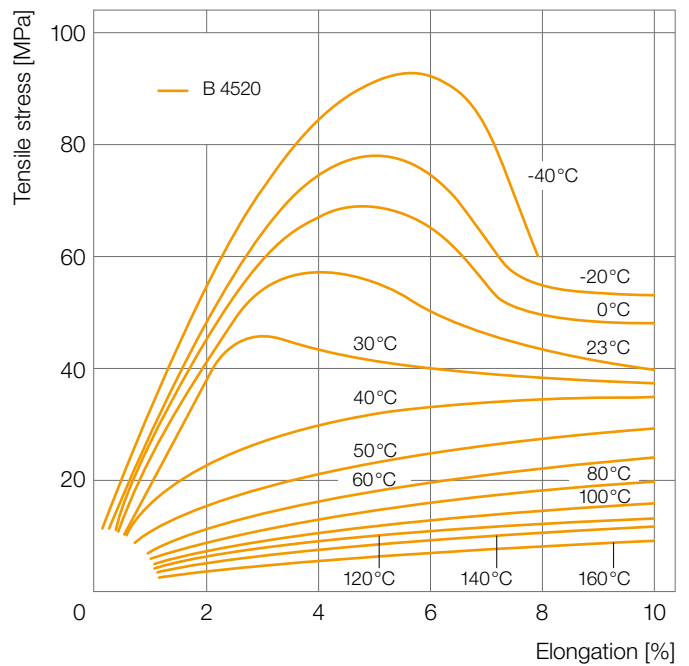

Fig. 5: Stress-strain diagrams for unreinforced Ultradur® at different temperatures (in accordance with ISO 527, take-off speed 50mm/min)

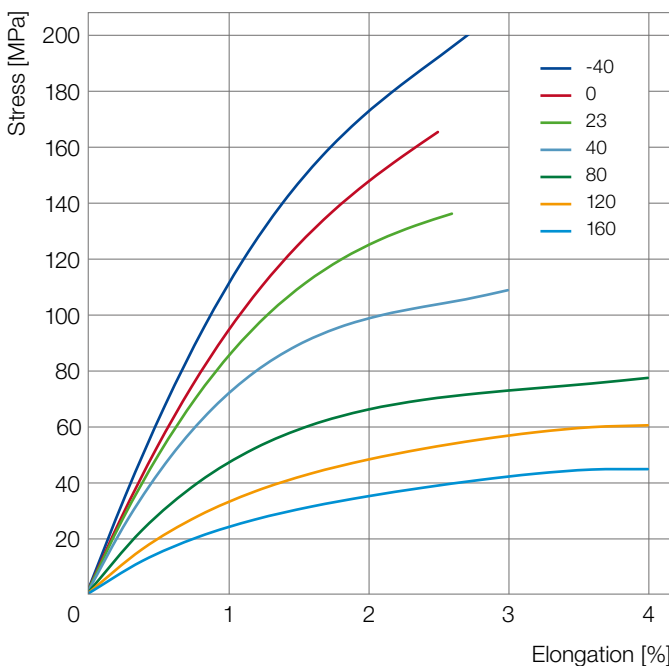
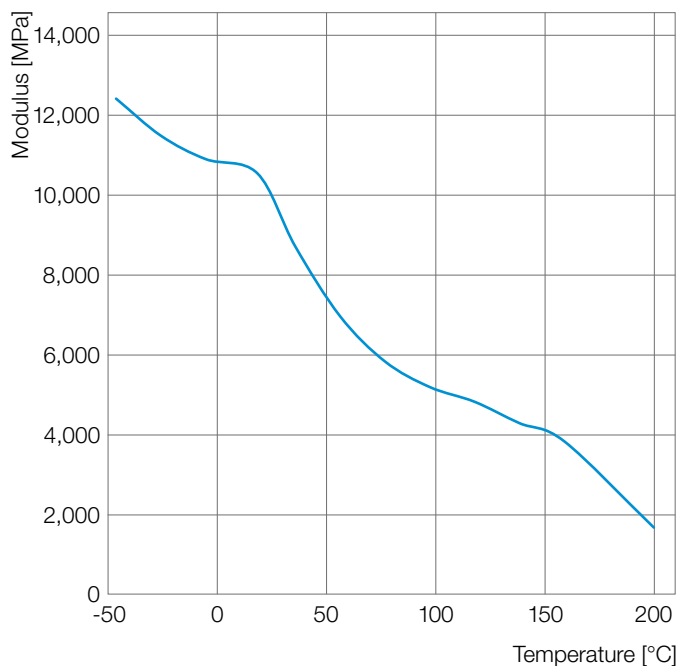

Fig. 6: Stress-strain diagrams for glass-fiber reinforced Ultradur® B 4300 G6 at different temperatures (in accordance with ISO 527, take-off speed 5 mm/min)



Property	Unit	B 4520	B 4300 G2	B 4300 G4	B 4300 G6	B 4300 G10
Glass content	Wt.-%	0	10	20	30	50
Impact strength +23°C	kJ/m ²	no break	38	58	72	65

Table 2: Dependence of the impact strength (ISO 179/1eU) on the glass-fiber content

Behavior under long-term static loading

The loading of a material under a static load for relatively long periods is marked by a constant stress or strain. The tensile creep test in accordance with DIN 53444 and the stress relaxation test in accordance with DIN 53441 provide information about extension, mechanical strength and stress relaxation behavior under sustained loading.

The results are illustrated as creep modulus plots, creep curves and isochronous stress-strain curves (Figs. 7 and 8). These graphs are just a selection from the extensive plastics database CAMPUS®.

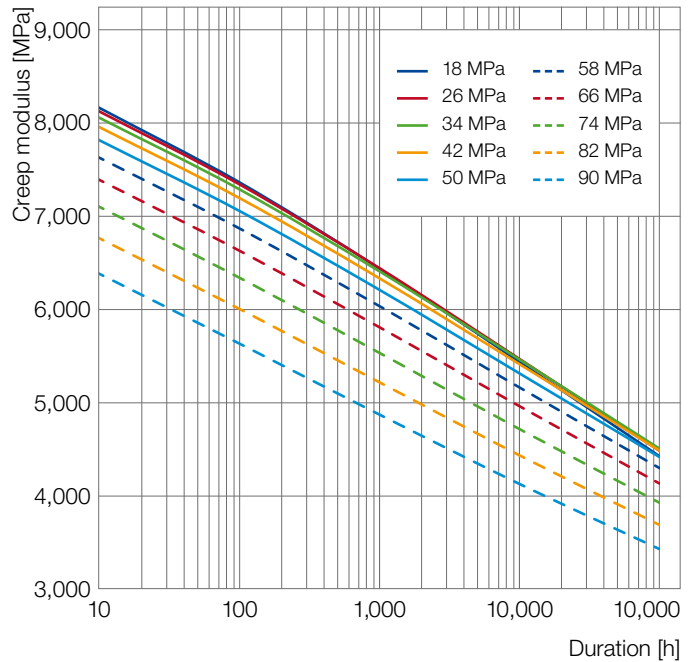

Fig. 7: Creep modulus curves for Ultradur® B 4300 G6 at 23°C

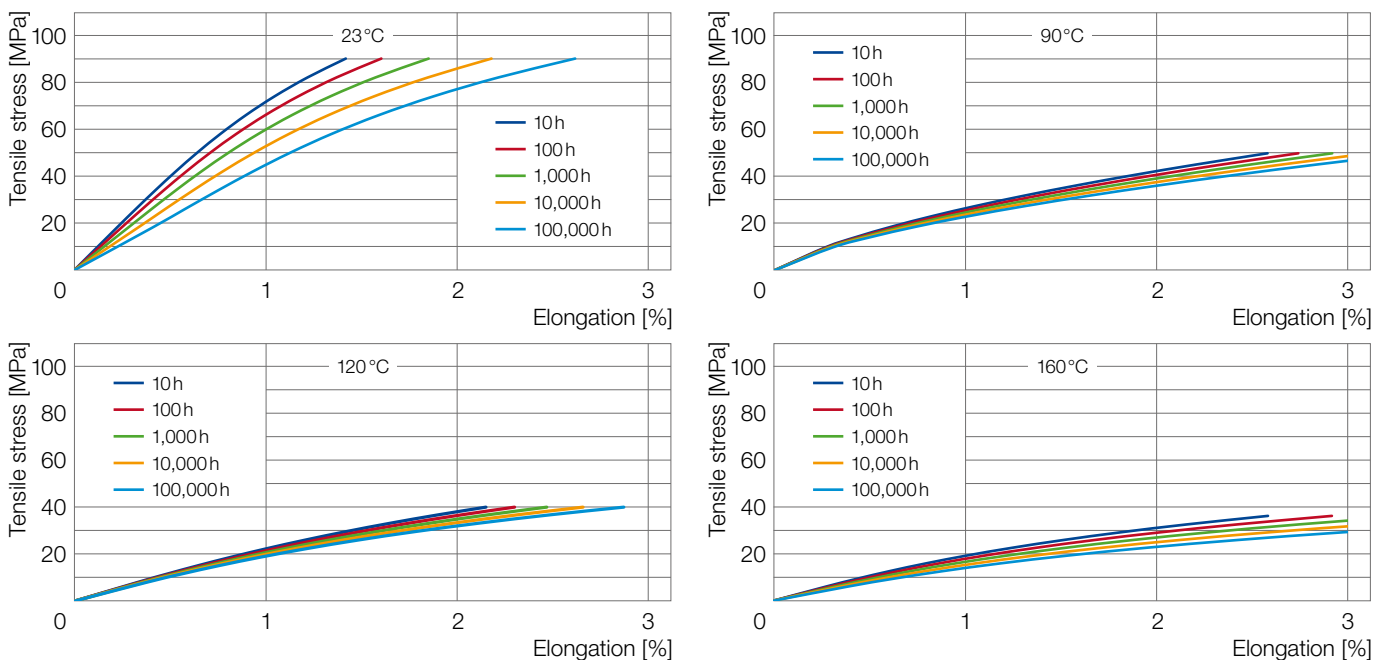

Fig. 8: Isochronous stress-strain curves for Ultradur® B 4300 G6 under normal conditions acc. to DIN 50014-23/50-2 and at 90°C, 120°C and 160°C acc. to DIN 53442

Behavior under cyclic loads, flexural fatigue strength

Engineering parts are frequently subjected to alternating or cyclic loads, which act periodically in the same manner on the structural part. The behavior of a material under such loads is determined in long-term flexural fatigue tests or in rotating bending fatigue tests (DIN 53442) up to very high load-cycle rates. The results are presented in Wöhler diagrams obtained by plotting the applied stress against the load-cycle rate achieved in each case (Fig. 9). The flexural fatigue strength is defined as the stress level a sample can withstand for at least 10 million cycles.

It can be gathered from the illustration that in the case of Ultradur® B 4300 G6 the flexural fatigue strength under normal conditions is 40MPa.

When applying the test results in practice it has to be taken into account that at high load alternation frequencies the parts may heat up considerably due to internal friction. In such cases, just as at higher operating temperatures, lower flexural fatigue strength values have to be expected.

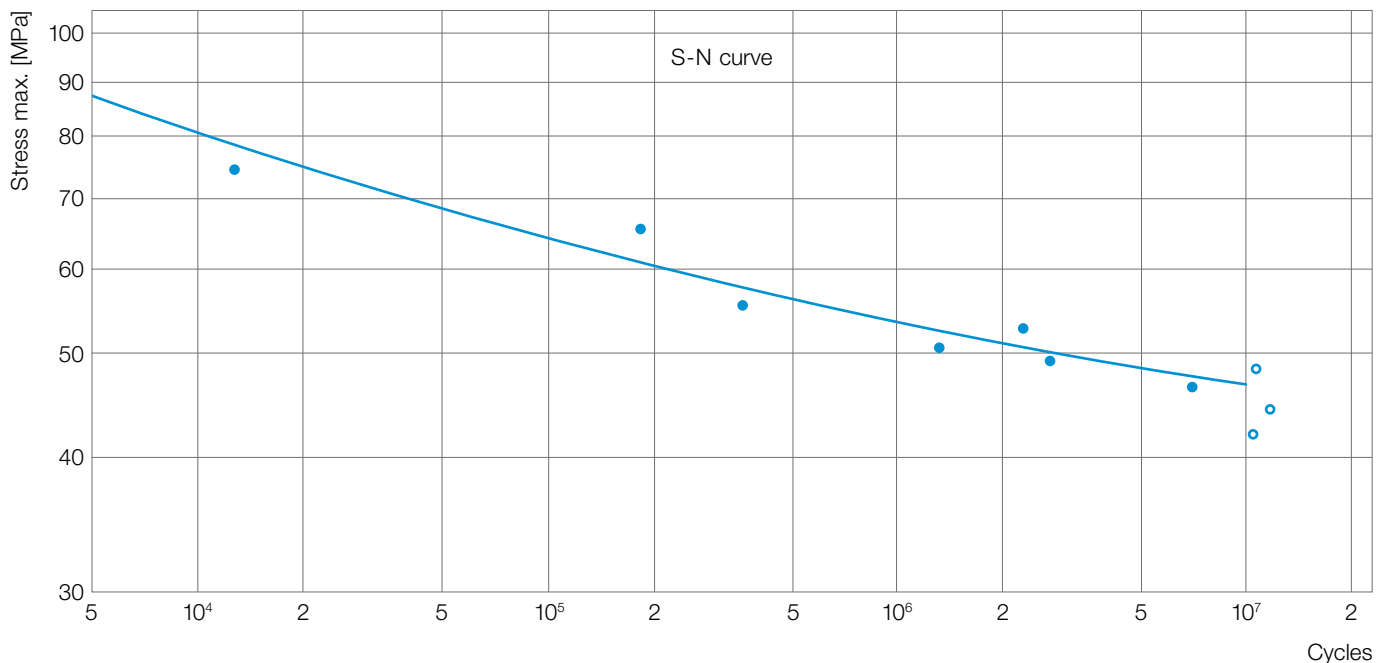

Fig. 9: Flexural fatigue strength of Ultradur® B 4300 G6 under normal conditions as defined by DIN 50014-23/50-2 in accordance with DIN 53442, injection-molded test specimen

Tribological properties

Ultradur® is suitable as a material for sliding elements due to its excellent sliding properties and very high resistance to wear.

Figures 10 and 11 show examples of friction values and wear rates for unreinforced and glass-fiber reinforced Ultradur® on a special tribological system having two different depths of roughness. Sliding properties depend strongly on the system so that tailor-made tests to the part in question might be necessary. The coefficient of sliding friction and the wear rate due to sliding friction depend on the contact pressure, the temperature of the sliding surfaces and the sliding distance covered. The surface roughness and the hardness of the paired material is decisive. The sliding speed has no appreciable effect if heating and modification of the sliding surfaces are avoided.

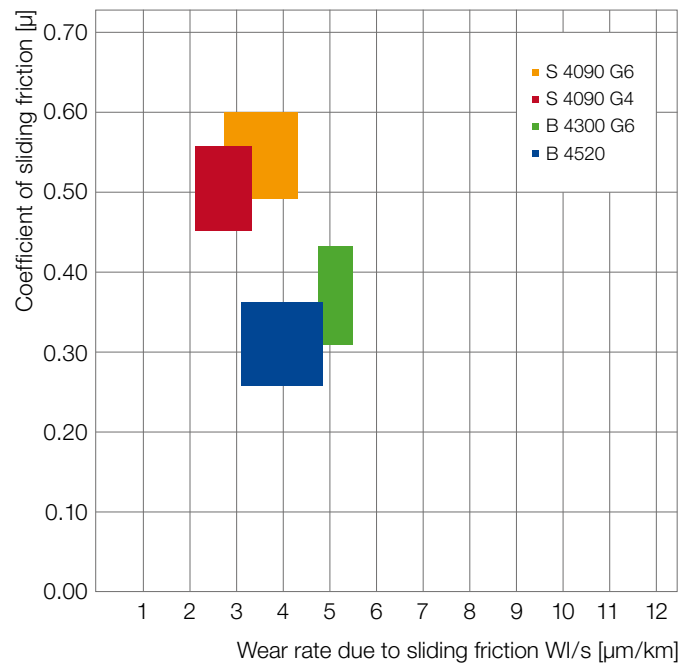

Fig. 10: Coefficient of sliding friction and wear rates of unlubricated Ultradur® at 0.15 μm depth of roughness; tribological system: pin-on-disk; base material: disk of 100 Cr 6/800 HV steel; opposing material: plastic; ambient temperature: 23°C; contact pressure: 1 MPa; sliding speed: 0.5 m/s

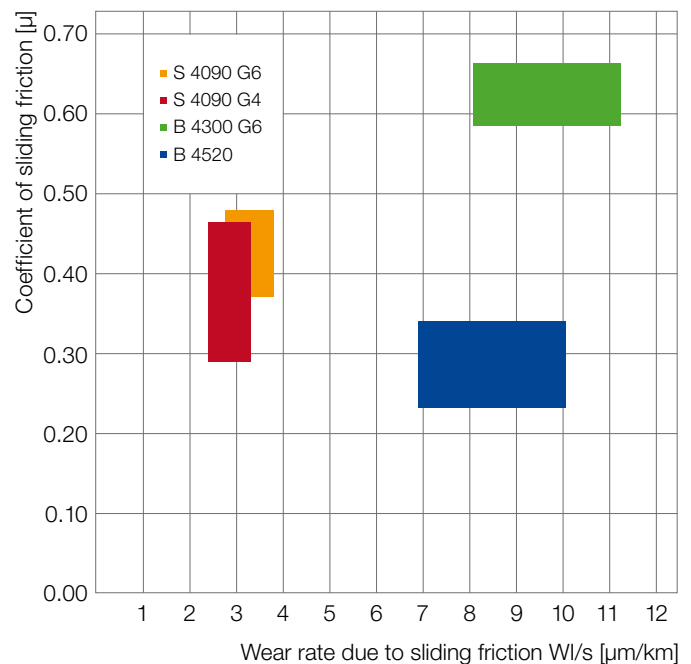

Fig. 11: Coefficient of sliding friction and wear rates of unlubricated Ultradur® at 3 μm depth of roughness; tribological system: pin-on-disk; base material: disk of 100 Cr 6/800 HV steel; opposing material: plastic; ambient temperature: 23°C; contact pressure: 1 MPa; sliding speed: 0.5 m/s

Thermal properties

As a partially crystalline plastic, Ultradur® has a narrow melting range between 220°C and 225°C. The high crystalline component makes it possible for stress-free Ultradur® moldings to be heated for short periods to just below the melting temperature without undergoing deformation or degradation.

Ultradur® is distinguished by a low coefficient of linear expansion. The reinforced grades in particular exhibit high dimensional stability when temperature changes occur. In the case of the glass-fiber reinforced grades, however, the linear expansion is determined by the orientation of the fibers. Because of glass-fiber reinforcement, the dimensional stability on exposure to heat (ISO 75) increases significantly by comparison with unreinforced grades.

Behavior on brief exposure to heat

Apart from the product-specific thermal properties the behavior of Ultradur® components on exposure to heat also depends on the duration and mode of application of heat and on the loading. The shape of the parts is also important. Accordingly, the dimensional stability of Ultradur® parts cannot be estimated simply on the basis of the temperature values from the various standardized tests.

The shear modulus and damping values measured as a function of temperature in torsion pendulum tests in accordance with ISO 6721-2 afford valuable insight into the temperature behavior. A comparison of shear modulus curves (Fig. 2) gives information about the different thermomechanical effects at low deformation stresses and speeds. Based on practical experience the thermal stability of well-manufactured parts is in accordance with the temperature values measured in the torsion pendulum tests in which the start of softening becomes apparent.

Heat aging resistance

Thermal aging is the continuous, irreversible change (degradation) of properties under the action of elevated temperatures. The determination of the aging characteristics of finished parts under operational conditions is often difficult to carry out because of the long service life required.

The test methods developed for thermal aging using standardized test specimens make use of the increasing reaction rate of chemical processes at higher temperatures. This dependence of service life on temperature described mathematically by the Arrhenius equation is the basis of the international standards IEC 60216, ISO 2578 and the US standard UL 746B.

The temperature index (TI) is defined as the temperature in °C at which the permitted limiting value (usually decline of the property to 50% of the initial value) is reached after a defined time (usually 20,000 hours). The temperature index is available for many products and various properties (e. g. tensile strength). The temperature indices are given in the Ultradur® product range.

In Figure 12 the tensile strength of Ultradur® B 4300 G6 is plotted as a function of storage time and storage temperature. From the graph a temperature-time limit in accordance with IEC 60216 of approx. 140°C after 20,000 hours can be extrapolated on the basis of a 50% decline in tensile strength (Fig. 13).

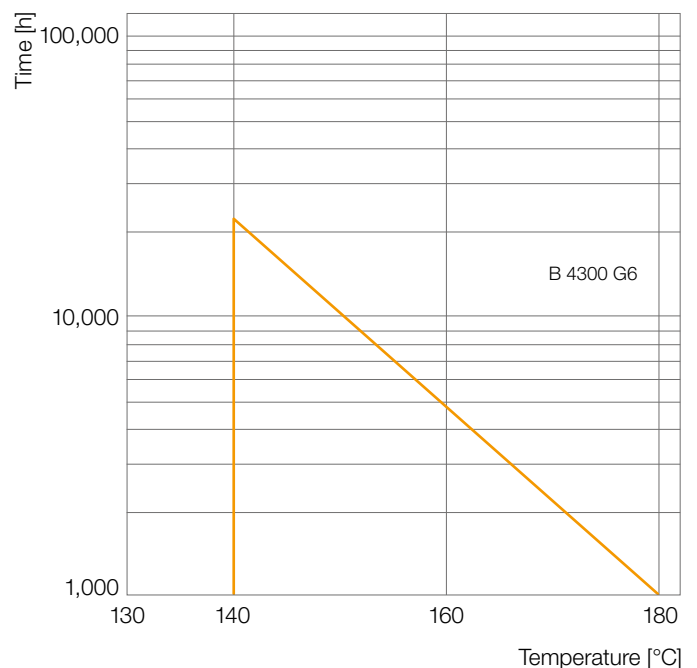

Fig. 12: Thermal endurance graph for glass-fiber reinforced Ultradur® (IEC 60216)

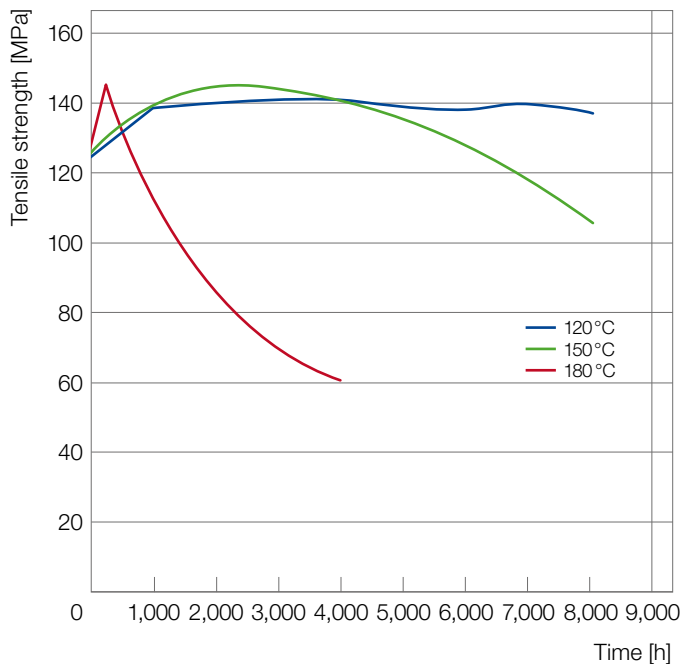

Fig. 13: Heat aging of Ultradur® B 4300 G6

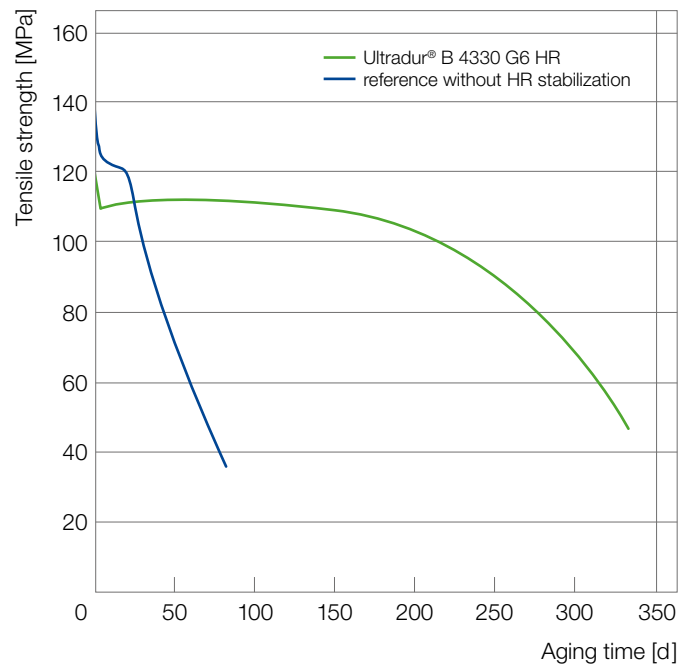

Fig. 14: Comparison of PBT GF30 without HR stabilization to Ultradur® B 4330 G6 HR: aging at 85°C/85% rel. humidity, tensile properties for 4 mm thick specimen (ISO 527, 1A)

Ultradur® moldings become only slightly discolored on long exposure to thermal stress in the aforementioned temperature-time limits. In the case of uncolored Ultradur® B 4520 for example, only a very slight change in color can be observed after exposure to a temperature of 110°C for 150 days. Even after storage for 100 days at 140°C discoloration due to oxidation is slight, i. e. the material is suitable for visible parts exposed to high temperatures, e. g. in the domestic appliance sector.

Hydrolysis resistance

With polyesters, contact with water – even in the form of atmospheric moisture – results, especially at elevated temperatures, in hydrolytic splitting of the polymer chains and thus in a weakening of the material. Important material properties such as strength, elasticity and impact strength suffer, if the material is hydrolytically damaged. In applications in which moisture can have an effect at higher temperatures over a relevant period of time, for example in automotive electronics, additives are generally added as hydrolysis stabilizers. These additives serve to counteract the chain splitting through hydrolysis, greatly slow down hydrolytic degradation and can thus prolong the life of a component many times over (Fig. 14).

The development of hydrolysis-stabilized Ultradur® grades provides processors with materials which combine the proven excellent properties of Ultradur® with a much higher level of resistance to the effects of moisture. This means that even applications in the highest stress classes can be achieved. BASF offers a series of HR-modified Ultradur® grades which are noted not only for having high hydrolysis resistance, but also offer processing benefits. In addition to B 4300 G6 HR LT, the range also comprises the impact-modified grades B 4330 G3 and G6 HR FC AQUA.

Electrical properties

Ultradur® is of great importance in electrical engineering and electronics. It is used in insulating parts, such as plug boards, contact strips and plug connections for example, due to its balanced range of properties. These include good insulation properties (contact and surface resistance) in association with high dielectric strength and good tracking current resistance together with satisfactory behavior on exposure to heat, in aging, and the possibility of meeting the requirements for increased fire safety by incorporation of flame-retardant additives. Electrical test values are compiled in the Ultradur® product range.

Figure 15 shows the dielectric constant and the dissipation factor as a function of frequency with reference to Ultradur® S 4090 G4. The electrical properties are not affected by the moisture content of the air.

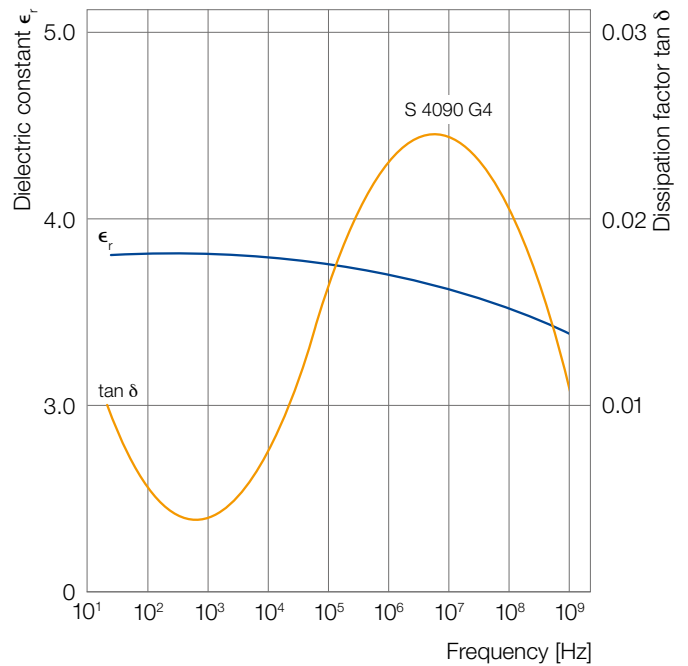

Fig. 15: Dielectric constant and dissipation factor for glass-fiber reinforced Ultradur® as a function of frequency



CEE NEO plug

Fire behavior

General notes

In the temperature range above 290 °C, flammable gases are formed. They continue to burn after they have been ignited. These processes are affected by many factors so that, as with all flammable solid materials, no definite flash point can be specified. The use of flame-retardant additives is intended to prevent fires from occurring in the first place (inflammation) or in the event of a fire minimize its spread (self-extinguishment). The decomposition products formed from charring and combustion are mainly carbon dioxide and water and, depending on the supply of oxygen, small amounts of carbon monoxide and tetrahydrofuran.

Tests

Electrical engineering

Different material tests are carried out to assess the fire behavior of electrical insulating materials. In Europe, the glow wire test according to IEC 60695-2-10 ff is frequently required. Another test carried out on rod-shaped samples is the classification according to "UL 94 – Standard, Tests for Flammability of Plastic Materials for Parts in Devices and Appliances" of Underwriters Laboratories Inc./USA.

Transportation

In modern traffic and transport engineering, plastics make a substantial contribution to ensuring the high performance capacity of road vehicles and trains. Materials used inside motor vehicles are governed by the fire safety requirements according to DIN 75200 and FMVSS 302, which are met by all Ultradur® grades with a wall thickness of more than 1 mm (burning rate < 100 mm/min).

The corresponding values can be found in the Ultradur® product range. For rail vehicles, in addition to different national regulations, a European standard, EN 45545, is drawn up which also contains requirements for the other effects of fire such as the density and toxicity of smoke gas.

Construction industry

Building materials for use in construction are tested according to DIN 4102 Part 1 "Fire behavior of building materials and components". Panels made of unreinforced and glass-fiber reinforced Ultradur® products (thickness of 1 mm, standard type of sample) are to be assigned to the building materials class B 2 as normal-flammability building materials (designation in the Federal Republic of Germany).

The classifications and measured results for the Ultradur® grades regarding fire behavior are summarized in Table 3.

Further literature for electrical insulating materials

The wide variety of existing applications and sets of rules can be difficult to comprehend. More detailed information and key material figures can be found in the following BASF brochures:

- Engineering Plastics for the E/E Industry – Standards and Ratings
- Engineering Plastics for the E/E Industry – Products, Applications, Typical Values
- Engineering Plastics for Automotive Electrics – Products, Applications, Typical Values

Ultradur	UL 94	Glow wire test IEC 60695 Part 2-12	FMVSS 302 (d ≥ 1 mm)
B 4520	HB (0.75 mm)	850 (≤ 2 mm)	reached
B 4300 G2-G10	HB (0.75 mm)	750 (2 mm)	reached
B 4300 K4-K6	HB (1.5 mm)	850 (3 mm)	reached
S 4090 G4-G6	HB (0.7 mm)	750 (3 mm)	reached
B 4406 G2-G6	V-0 (0.4 mm)	960 (1 mm)	reached
B 4441 G5	V-0 (0.4 mm)	960 (1 mm)	reached
B 4450 G5	V-0 (0.4 mm)	960 (1 mm)	reached
B 4450 G5 HR	V0 (≥ 0.4 mm)		
B 4440	V-0 (0.4 mm)		
B 4440 G2	V-0 (0.4 mm)		

Table 3: Fire behavior

Resistance to chemicals and behavior on exposure to weather

Resistance to chemicals

Ultradur® is highly resistant to many common solvents, such as alcohols, ethers, esters, higher aliphatic esters and aliphatic hydrocarbons, and to fats and oils, such as fuels, brake fluid and transformer oils.

At room temperature, Ultradur® is only soluble in very special solvents, such as highly fluorinated alcohols. At elevated temperatures, Ultradur® is also dissolved by mixtures of o-dichlorobenzene and phenol, or tetrachloroethane and phenol, as well as o-chlorophenol and dichloroacetic acid. At room temperature, Ultradur® is resistant to water and aqueous solutions of most salts. It shows limited resistance to diluted acids and is not resistant to aqueous alkalis.

Polyesters can be damaged by hydrolysis; brief contact with warm or hot water does not pose any problems (Fig. 16). For long-term use, it is advisable to use hydrolysis-resistant Ultradur® HR grades.

Further information about the effect of solvents and chemicals can be found in the brochure “Ultramid®, Ultradur®, Ultraform® – Resistance to chemicals” and also at www.plasticsportal.eu. Model investigations in the laboratory allow a relative comparison between different materials and thus represent a basis for preselecting suitable materials for a specific application. However, they cannot generally serve as a substitute for a realistic test.

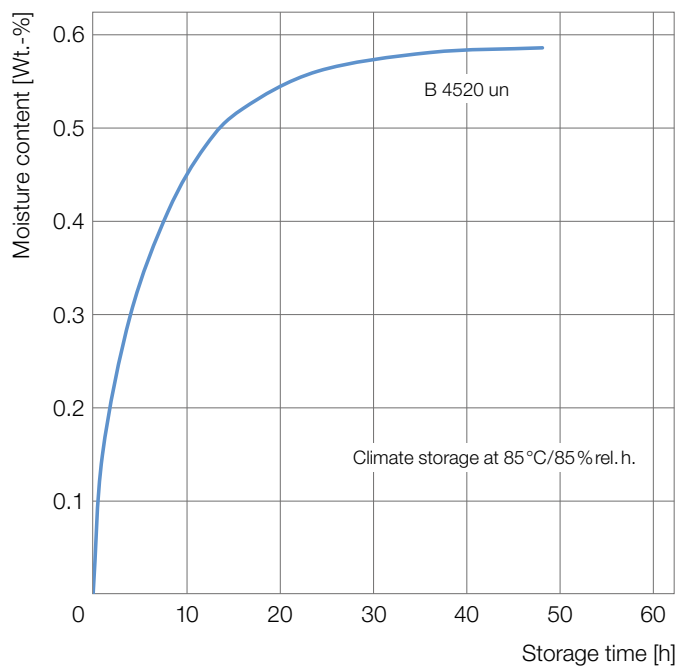

Fig. 16: Absorption of moisture by unreinforced Ultradur as a function of time (plaque thickness 2.5 mm)

Behavior on exposure to weather

As has been shown by 3-year exposure to weather in the open in Central Europe, moldings made from Ultradur® barely tend to discolor, and their surface scarcely changes. Mechanical properties too, such as rigidity, tensile strength and tear strength, are hardly affected. After a weathering test for 3,600 hours in the Xenotest 1,200 device, the values for tensile strength still amount to 90 % of the initial value. On the other hand, elongation at break is more adversely affected. Experience has shown that a weathering test for 3,600 hours in the Xenotest 1,200 device corresponds to five to six years of weathering in the open air.

Parts for outdoor use should be manufactured from black-colored material, as these are very resistant to damage to the surface by UV light in comparison to uncoated, reinforced plastics. Fiber-reinforced grades such as Ultradur® B 4040 G4/G6/G10 which offer outstanding surface quality accompanied by high resistance to UV radiation are suitable for parts subject to particularly extreme exposure.



Pressure sensor

The processing of Ultradur®

General notes

As a general rule Ultradur® can be processed by all methods known for thermoplastics. The main methods, however, are injection molding and extrusion. Complex moldings are economically manufactured in large numbers from Ultradur® by injection molding. The extrusion process is used to produce film, semi-finished products, pipes, profiled parts, sheet and monofilaments. Semi-finished products are for the most part machined further by means of cutting tools to form finished moldings.

The following text examines various topics relating to the injection molding and extrusion of Ultradur®. Further general and specific information can be found on the internet via www.plasticsportal.eu or at the Ultra-Infopoint, ultraplaste.infopoint@basf.com. More detailed information on the injection molding of individual products is provided in the respective processing data sheets.

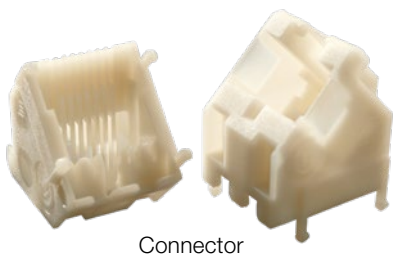

Moisture and drying

Thermoplastic polyesters such as polybutylene terephthalate (PBT) are susceptible to hydrolysis. If the moisture content during fusion in the course of processing is too high, degradation will occur. This results in cleavage of the molecular chains and hence in a reduction in the mean molecular weight.

In practice this manifests itself in a loss in impact resistance and elasticity. The decline in strength usually turns out to be less marked. Degradation of the material can be demonstrated by determining the viscosity number according to ISO 1628-5 or the melt volume index according to ISO 1133. Particular care therefore has to be devoted to pretreatment of the granules and processing in order to guarantee high quality of the finished parts and low fluctuation in quality.

Ultradur® should generally have a moisture content of less than 0.04% when being processed. In order to ensure reliable production, therefore, pre-drying should generally be the rule and the machine should be loaded via a closed conveyor system. Pre-drying is also recommended for the addition of batches, e.g. in the case of self-coloring.

In order to prevent the formation of condensed water, containers stored in unheated rooms must only be opened when they have attained the temperature in the processing area. This can possibly take a very long time. Measurements have shown that the interior of a 25-kg bag originally at 5°C had reached the temperature of 20°C of the processing area only after 48 hours. It should be noted that Ultradur® tends to absorb water when stored in humid air.

Of the various dryer systems possible, the dry air dryer has proved to be technically and economically superior. Drying times for these devices amount to 4 hours at 80°C to 120°C. In general the directions of the equipment manufacturer should be observed in order to achieve the desired drying effect. The moisture content of the granules must be measured during processing. The use of vented screws is inadvisable.

Production stoppages and change of material

During brief production stoppages the injection molding screw should be advanced to the forwardmost position and when downtimes are relatively long the barrel temperature should be additionally lowered. Before restarting after stoppages thorough purging is required. When there is a change of material the screw and barrel must be cleaned in advance. HDPE of high molecular weight as well as glass-fiber reinforced HDPE and GFPP have proved to have good cleaning action in such cases.

Reprocessing

Reprocessing of reground parts and sprue is usually possible. Since degradation to a greater or lesser degree can occur in each processing cycle, checks should first of all be made as to how extensive this is. Checks on the viscosity number in solution or the melt viscosity provide useful information. If the material was handled gently in the first pass then as a rule up to 25% of the regranulated material can be mixed with the fresh granules without any decline in the characteristics of the material.

In the case of flame retardant products limits to the quantity of regrind permitted have to be observed (e.g. by means of UL specifications). When regrind is added care has to be taken that there is adequate predrying (see section on "Moisture and drying").

Self-coloring

Further shades other than those in our product range can be made up by means of self-coloring using masterbatches. When choosing the masterbatch attention should be paid to a high level of compatibility with Ultradur® so that its range of properties is not affected. We recommend PBT-based color batches. In the case of flame-retardant products care must be taken that only masterbatches are used which do not change its rating (e.g. according to UL). The Ultra-Infopoint will be happy to provide addresses of suppliers of suitable masterbatches.



Pump pressure housing

Injection molding

Injection unit

Single-flighted, shallow-cut three-section screws having a L/D ratio of 20-23 are suitable for processing Ultradur®. For the same screw diameter shallow flighted screws ensure a shorter residence time of the melt in the cylinder and a more homogeneous temperature distribution in the melt (Figs. 17 and 18).

When processing GF-reinforced PBT types hard-wearing steels should be used for the cylinder, screw and non-return valve. At higher holding pressures the non-return valve must also prevent backflow of the melt out of the front of the screw so that sink marks or voids in the part are reliably avoided. The need for a check on the adequacy of sealing or excess play is always indicated when the melt cushion in the filled mold reduces markedly in the holding phase. Due to the viscous melt Ultradur® can be processed both with an open nozzle as well as with a shut-off nozzle. The use of nozzle heater bands is recommended.

Sprue systems and tool design

For Ultradur® both conventional cold runners as well as hot runner systems can be used. When using hot runner systems and hot nozzles, externally heated systems are safer due to the more homogeneous melt and a secure purging routine. Diversions have to be designed in a manner favoring flow in order to avoid deposits. Here furthermore, good thermal isolation at the gate is important. In this way the temperatures of the heated and cooled regions can be more directly controlled and the total energy requirements for heating and cooling are reduced. The most suitable type of gate depends on the specific application and must therefore be selected for each case.

At mold temperatures above 60°C the installation of thermal insulation panels between the machine platen and the mold base plate should be considered. As a result less heat energy is lost and the temperature distribution in the mold is more uniform.

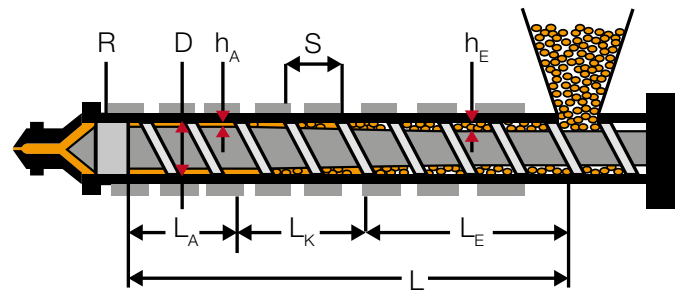

D	outer diameter of the screw	
L	effective screw length	20-23 D
L _E	length of the feed section	0.5-0.55 L
L _K	length of the compression section	0.25-0.3 L
L _A	length of the metering section	0.2 L
h _A	flight depth in the metering section	
h _E	flight depth in the feed section	
S	pitch	1.0 D
R	non-return valve	

Fig. 17: Screw geometry – terms and dimensions for three-section screws for injection-molding machines

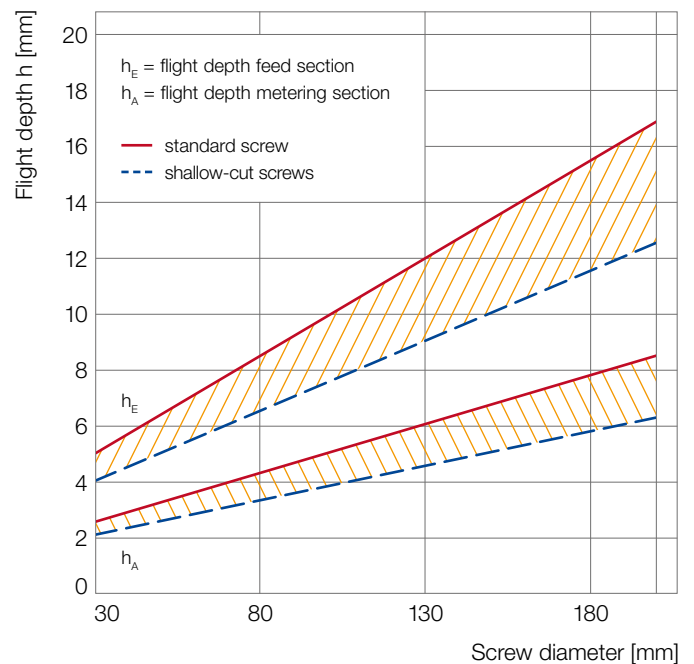

Fig. 18: Screw flight depths for three-section screws in injection-molding machines

Temperature control in the mold should be so effective that even over long production periods the desired temperatures are attained in all contour-forming regions or selective temperature changes can be produced at particular points by means of independent temperature control circuits. The quality of an effective cooling system is shown in that temperature fluctuations during the cycle phase are as small as possible. Draft angles of at least 1° per side allow problem-free demolding.

Metering and back pressure

When metering in, the peripheral screw speed and the level of back pressure have to be limited with a view to gentle handling of the material. Gentle infeed is guaranteed for peripheral screw speeds of up to 15 m/min. Figure 19 shows the speeds to be set as a function of the screw diameter. The screw speed should be chosen so that the time available in a cycle for plastification is largely used up. The back pressure, which should ensure improved homogeneity of the melt and is therefore desirable, should be limited to 100 bar (specific pressure) due to the risk of excessive shear. Good feed behavior is best achieved by means of rising temperature control. This is illustrated in Figure 20.

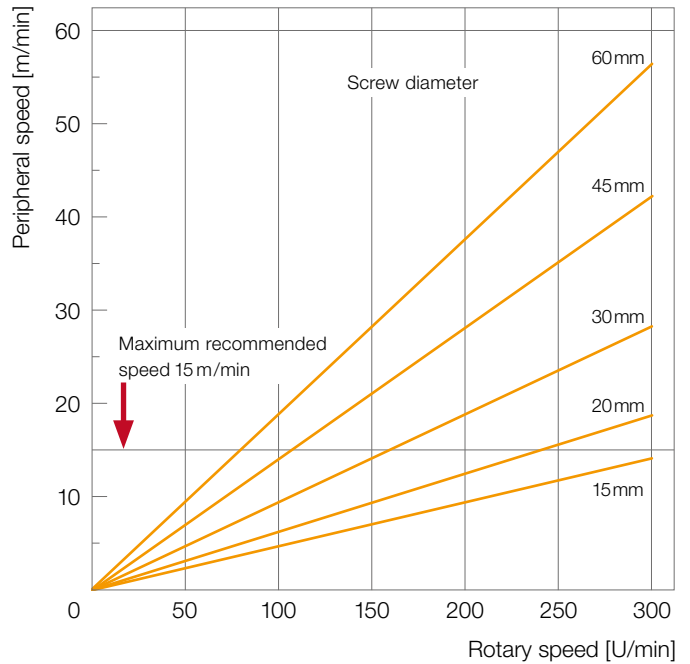

Fig. 19: Peripheral screw speed as a function of rotary speed and screw diameter

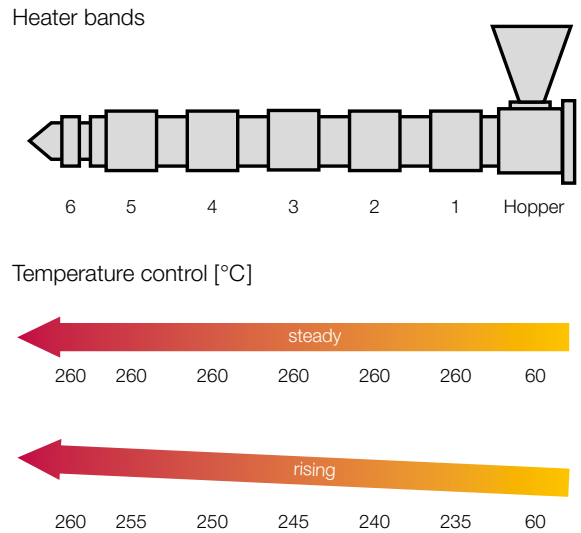

Fig. 20: Examples of cylinder temperature control for Ultradur®

Processing temperature and residence time

The recommended range of melt temperatures for the various Ultradur® grades is 250°C to 280°C. In order to work out the optimum machine setting a start should be made at the temperature of 260°C. The choice of melt temperature depends on the flow lengths and wall thickness and on the residence time of the melt in the cylinder. Unnecessarily high melt temperatures and excessively long residence times of the melt in the cylinder can bring about molecular degradation. Figure 21 shows an example illustrating how the viscosity number acts as a measure of the molecular weight as a function of the melt temperature and residence time.

Based on experience material degradation of less than 10 cm³/g to 12 cm³/g based on the measured viscosity in solution of the granules and the molding is tolerable. In the event of values higher than this the processing parameters and pretreatment should be checked. Detailed information is available in the product-specific processing data sheet.

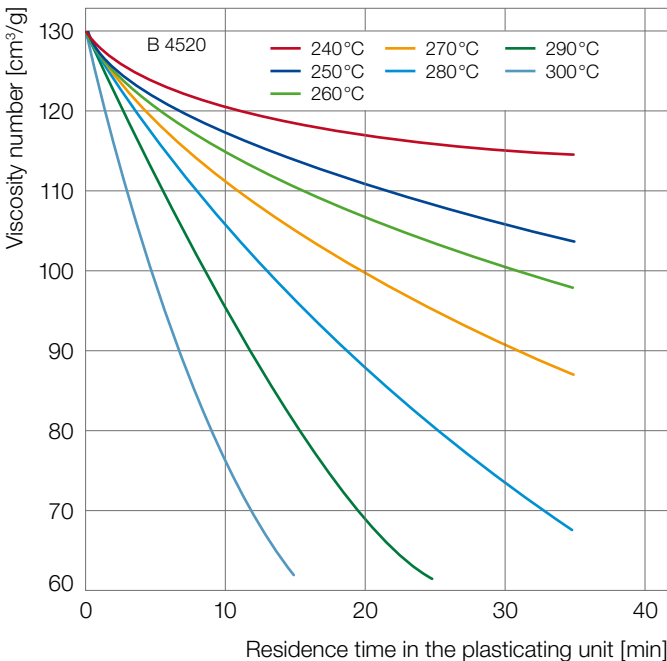

Fig. 21: Reduction of viscosity number of Ultradur® test specimens as a function of the melt temperature and residence time in the plastication unit

Mold surface temperature

Mold surface temperatures should lie in the range of 40°C to 80°C for unreinforced materials and 60°C to 100°C for reinforced materials, if needed also higher. These temperatures can usefully be attained using water systems as tempering medium. In the case of components with high demands on surface quality, especially in the case of glass-fiber reinforced grades, care should be taken that the mold surface temperature is at least 80°C or higher.

Since the mold temperature has an effect on shrinkage, warpage and surface quality it is of great importance for the dimensional accuracy of parts. The effect of mold surface temperature on shrinkage behavior is illustrated in Figures 24 to 28 with reference to the examples of Ultradur® B 4520 and B 4300 G6.

Flow behavior and injection speed

The speed at which the mold is injected has an impact on the quality of the molded parts. Rapid injection encourages even solidification and the quality of the surface especially in the case of parts made of glass-fiber reinforced Ultradur®. However, with molded parts that have very thick walls, it may be appropriate to reduce the injection speed in order to avoid a free jet.

The flow behavior of plastic melts, which is of great importance for the tool filling process, can be assessed in practical terms through what is known as the spiral test using spiral molds on commercial injection molding machines. The flow path covered by the melt – the length of the spiral – is a measure for the flowability of the processed material. The spiral lengths for some selected Ultradur® grades are given in Figure 22.

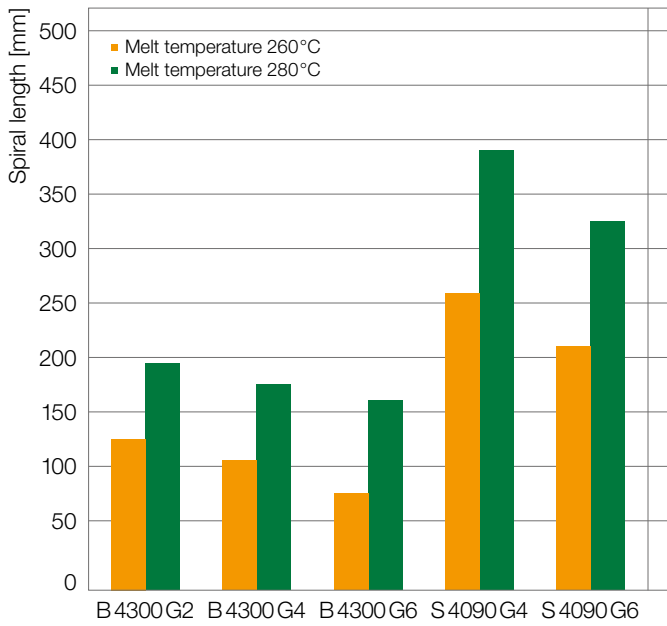

Fig. 22: Flow behavior of glass-fiber reinforced Ultradur® grades; spiral length as a function of melt temperature; wall thickness 1.5 mm

Shrinkage

The ISO 294-4 standard specifies terms and measurement methods for processing shrinkage. According to this, shrinkage is defined as the difference between the dimensions of the mold and those of the molded part at room temperature. It results from the volume contraction of the molding compound in the injection mold as a result of cooling, a change in the aggregate condition and crystallization. It is determined by the geometry (free or impeded shrinkage) and the wall thickness of the molded part. In addition, the gate position and size, the processing parameters and the storage time and temperature also play a crucial role. The interaction between these different factors makes it difficult to predict the shrinkage exactly in advance.

A useful resource for the designer are the shrinkage values determined on the board measuring 60 mm · 60 mm, which is molded via a film gate, for it shows the minimum and maximum shrinkage due to the high orientation of the direction of flow. The value measured on the test box (Fig. 23) can serve as a guideline for an average shrinkage that occurs in a real component as the flow fronts tend to run concentrically from the gate pin here.

In the product range overview and in the data sheets, guidelines for the shrinkage of the Ultradur® grades are specified in the product range.

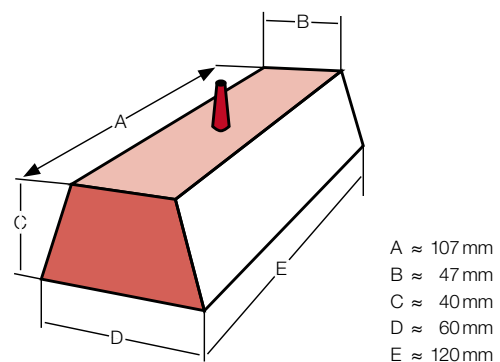

Fig. 23: Test box

In order to illustrate the influence of some processing parameters, the shrinkage is presented by way of example as a function of the mold surface temperature for wall thicknesses of 1.5 and 3 mm for unreinforced Ultradur® B 4520 in Figure 24 and for glass-fiber reinforced Ultradur® B 4300 G6 in Figure 25. Additionally in this investigation the holding pressure was varied in stepwise manner from 500 through 1000 to 1500 bar. The test component was a test box as shown in Figure 23. The specified shrinkage values were measured along the longitudinal direction of the box.

Depending on the processing conditions, aftershrinkage of the components can occur. Figure 26 for unreinforced Ultradur® B 4520 and Figure 27 for glass-fiber reinforced Ultradur® B 4300 G6 give an impression of how large aftershrinkage can be as a function of the mold surface temperature.

After storage for 60 days at room temperature only the molded parts produced at low mold temperatures exhibited small dimensional variations. After tempering, i. e. hot storage for 24 hours at 120 °C, the same parts exhibited marked aftershrinkage, especially those produced at low mold temperatures. As the mold surface temperature rises aftershrinkage steadily drops. This behavior should be taken into account when designing parts for use at elevated operational temperatures. The Ultradur® grades S 4090 G2-G6 represent

alternatives having lower shrinkage. The shrinkage and warpage behavior of Ultradur® S 4090 G4 are compared with those of Ultradur® B4300 G4 and B4040 G4 in Figures 28 and 29.

Warpage

The warpage of an injection-molded part is caused mainly by differential shrinkage in the direction of flow and in the direction transverse to this. Warpage is often particularly noticeable in the case of glass-fiber reinforced materials. In addition, this increases as the mold surface temperature rises. The warpage is also dependent on the shape of the molded parts, the wall thickness distribution, the gate position and the processing conditions.

On the other hand shrinkage in the direction of flow and transverse to this is approximately the same in unreinforced, mineral-filled and glass-bead filled products. Injection-moldings which due to their design tend particularly to warp should therefore be manufactured as far as possible from these Ultradur® grades or from the lower-warpage glass-fiber reinforced Ultradur® S grades. In many cases warpage-free moldings can be produced by differential temperature control of the mold parts. Further information can be obtained via www.plasticsportal.eu.

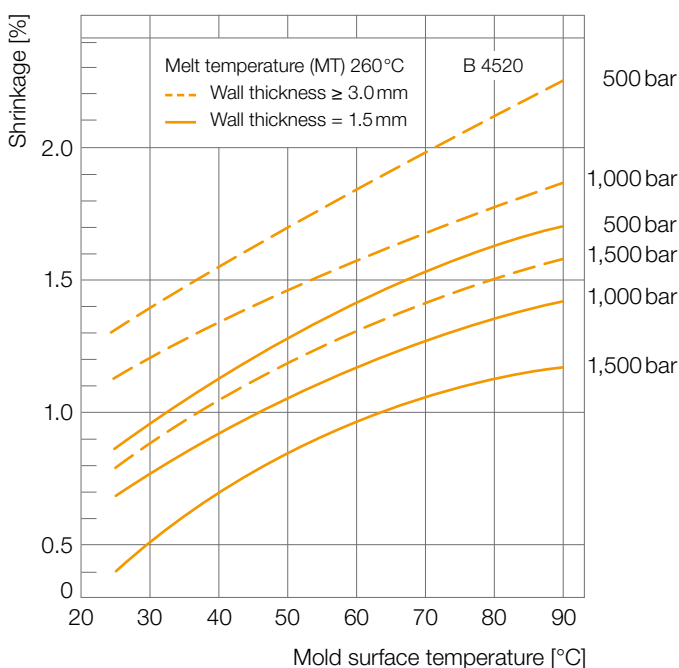

Fig. 24: Shrinkage as a function of mold temperature, part thickness and holding pressure (500, 1,000 and 1,500 bar) for unreinforced Ultradur®

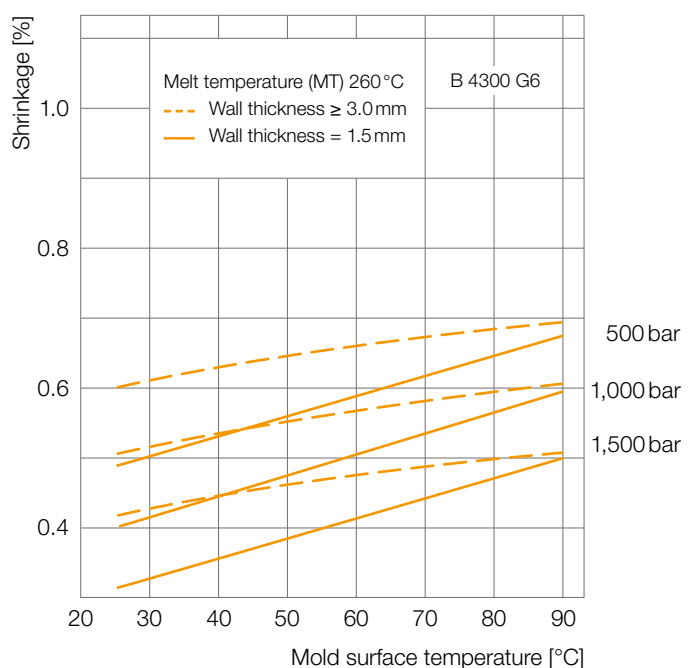

Fig. 25: Shrinkage as a function of mold temperature, part thickness and holding pressure (500, 1,000 and 1,500 bar) for glass-fiber reinforced Ultradur®

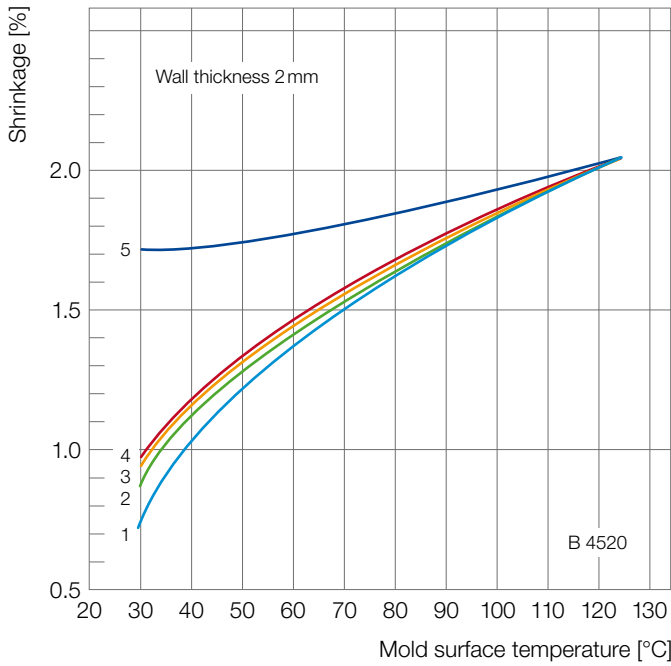

Fig. 26: Effect of mold temperature and post-molding conditions on the shrinkage of unreinforced Ultradur®*

* Mold: test box, dimension measured A: 107mm, melt temperature: 265°C, holding pressure: 660 bar

- 1st Shrinkage measured 1 hour after injection
- 2nd After shrinkage measured 24 hours after injection.
- 3rd After shrinkage measured 14 days after injection.
- 4th After shrinkage measured 60 days after injection.
- 5th After shrinkage measured after tempering (for 24 hours at 120°C).

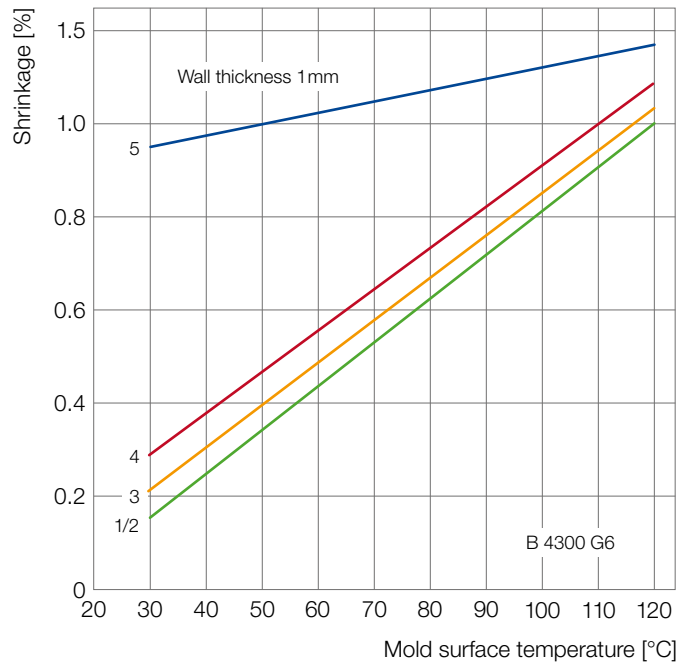

Fig. 27: Effect of mold temperature and post-molding conditions on the shrinkage of glass-fiber reinforced Ultradur®*

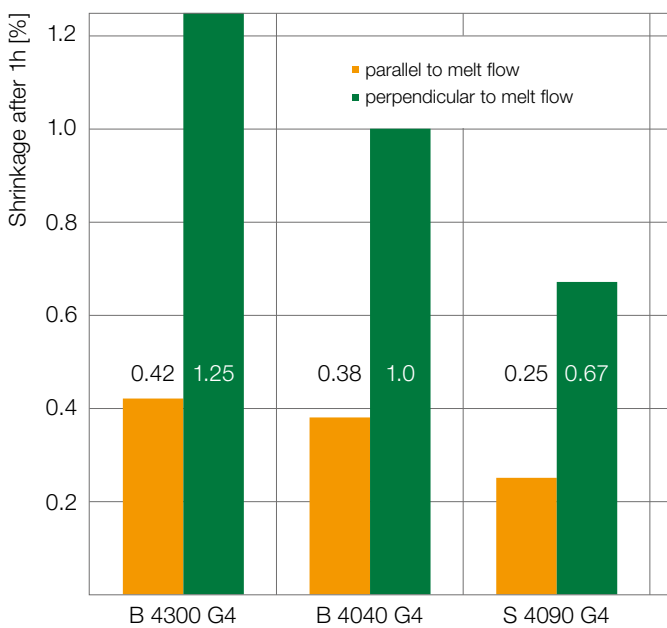

Fig. 28: Shrinkage behavior of glass-fiber reinforced Ultradur® (Test box with walls 1.5 mm thick; melt temperature = 260°C; mold surface temperature = 80°C)

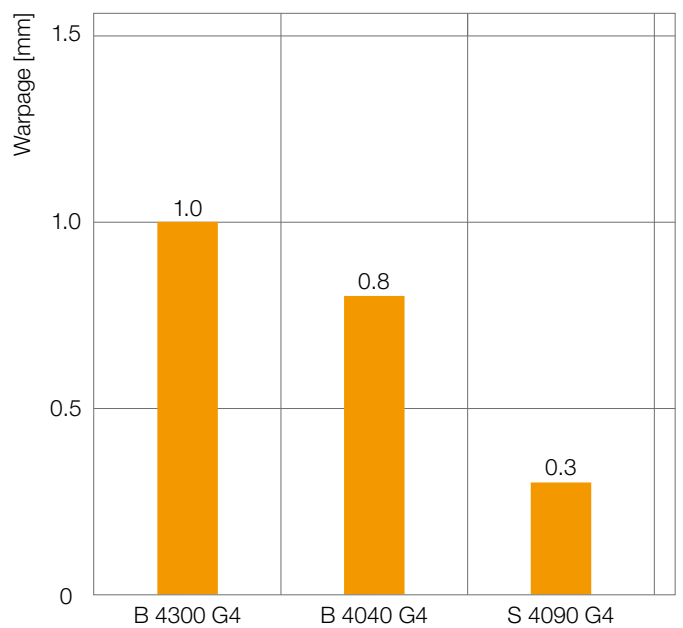

Fig. 29: Warpage behavior of glass-fiber reinforced Ultradur® (Test box with walls 1.5 mm thick; melt temperature = 260°C; mold surface temperature = 80°C)

Extrusion

Applications, screw geometry

The following Ultradur® grades listed in order of rising viscosity are available for extrusion:

- Ultradur® B 2550/B 2550 FC
- Ultradur® B 4500/B 4500 FC
- Ultradur® B 6550/B 6550 FC/B 6550 L/B 6550 LN/
B 6551 LNI R01/B 6554 LNI

Ultradur® B 2550 is suitable for the production of monofilaments and bristles. Ultradur® B 4500 is suitable for the extrusion of flat films, Ultradur® B 6550 for the extrusion of thin-walled and thick-walled tubes, hollow and solid profiles and semi finished parts.

Ultradur® B 6550 L and B 6550 LN have been developed for producing buffer tubes used in fiber optic cables. Ultradur® B 6550 L is additionally modified with lubricant for a better feeding performance. Ultradur® B 6550 LN is recommended when tubes with a higher stiffness are required. Ultradur® B 6551 LNI R01 was specially developed for “Dry Tubes”, which is characterized by high stiffness and improved hydrolysis stability. The Ultradur® B 6550 LNX, on the other hand, is optimized for so-called “micro tubes” and allows significantly thinner wall thicknesses and diameter.

Extruded Ultradur® B 6550 LN, B 6551 LNI R01 und B 6554 LNI profiles – circular, square and hollow rods together with sheet and flat bars – are principally used as semi-finished parts for machine-cutting to produce engineering articles for which production by injection-molding does not come into consideration due to the small numbers involved.

Tubes made from Ultradur® B 6550 L, B 6550 LN, B 6551 LNI R01 und B 6554 LNI are resistant to fuels, oils and greases and show favorable sliding friction and wear properties.

The ability of Ultradur® tubes to withstand compressive loads is remarkably high not only at normal temperatures but also at higher temperatures. They can for example withstand burst pressures higher by at least a factor of 1.5 than polyamide tubes of comparable size.

Thin-walled pipes made from Ultradur® B 6550 L and B 6550 LN are therefore in many cases suitable for fuel and oil pipes, pneumatic and hydraulic control lines, pipes for central lubrication systems, Bowden cables and other cable systems.

Ultradur® B 6560 M2 FC TF, the world's first deep-drawn PBT, combines the well-known properties of the Ultradur® such as the high melting point, the low water absorption, high dimensional stability and good barrier properties. Due to its very high melting strength, the Ultradur® B 6560 M2 FC TF becomes the material of choice for the extrusion of films and the deep drawing of packaging or technical components.

The processing properties of these grades are similar to those of polyamide 6. In general, therefore, the product can be processed on machines suitable for polyamides. The same is true for the screw geometry. Experience to date has shown that all Ultradur® extrusion grades can be extruded using the same three-section screws which have also proved to be effective in the processing of polyamides.

For Ultradur® the compression section and the flight depth ratio are even more important than for polyamide. The length of the compression zone should, therefore, not exceed 4-5D and the flight depth ratio should be approximately 3:1.



Food trays

Production of semi-finished products and profile sections

Ultradur® B 6550, B 6550 LN, B 6551 LNI R01 und B 6554 LNI is formed into circular, square, square-section and hollow rods under pressure by the cooled-die extrusion method, i. e. with cooled or temperature-controlled mold pipes. Due to the necessarily lengthy residence time of the melt, the melt temperature has to be kept as low as possible.

In contrast with polyesters based on polyethylene terephthalate the temperature of the cooled die in the case of Ultradur® need not be elevated, i. e. temperature control can be effected with water at room temperature. If the melt temperature has to be reduced due to increasing layer thickness it is, however, more favorable in respect of surface quality and state of stress in the parts to operate with water of higher temperature (60°C to 80°C; see the processing example for the production of round-section rods in Table 4). As with other partially crystalline thermoplastics, suitably high pressures are also needed in the case of Ultradur® for compensating for the volume shrinkage occurring on solidification of the melt.

Rod diameter	ø 60mm
Extruder	ø 45mm, L/D = 20
Screw – Section lengths – Flight depths	$L_E = 9D, L_K = 3D, L_P = 8D$ $h_1/h_2 = 6.65/2.25$
Temperature settings – Adapter – Die (heated part) – Die (cooled part)	235/245/250°C 240°C 250°C 20°C
Screw speed	16 U/min
Melt pressure	approx. 30 bar
Take-off speed	27 mm/min
Output	5.9kg/h

Table 4: Rod extrusion example for Ultradur® B 6550 LN

Production of sheet

Ultradur® B 6550 LN, B 6551 LNI R01 und B 6554 LNI sheet and slab, are produced on commercial, horizontally arranged installations having a sheet die, three-roll polishing stack and a following take-off unit. The sheet die should have lips which extend up close to the nip. The temperature control of the rolls depends on the sheet thickness in question and ranges from 60 to 170°C (for processing example see Table 5). The throughput and off-take rate are matched to one another in such a way that a small, uniform bead is formed over the width of the roll ahead of the nip. The uniformity of this bead is of great importance for the tolerances and surface quality of the sheet.

Sheet dimensions	780mm · 2mm		
Extruder	ø 90 mm, L/D=30		
Screw – 3-section lengths – Flight depths	$L_E = 11,5D, L_K = 4,5D, L_P = 14D$ $h_1/h_2 = 14,0/4,3$		
Die	800mm		
Temperature settings – Hopper – Barrel – Adapter – Die	40°C 215/220/235/260/230/225/220/220°C 230°C throughout 230°C		
Three-roll-stack	300mm roll diameter		
	Temperature	top	50°C
		center	115°C
		bottom	170°C
Screw speed	34 U/min		
Melt temperature	256°C		
Take-off speed	0.76m/min		
Output	100.8kg/h		

Table 5: Sheet extrusion example for Ultradur® B 6550 LN

Production of tubes

Tubes made from Ultradur® B 6550 L, B 6550 LN, B 6551 LNI R01 and B 6554 LNI with diameters up to approx. 8 mm and a wall thickness of 1 mm are produced by the vacuum water bath calibration method. Both sizing tubes and sizing plates are suitable for calibration. In both cases the internal diameter is chosen to be approximately 2.5% greater than the desired outer diameter of the tube to be produced. Based on experience this difference corresponds to the shrinkage in processing. To achieve the highest possible haul-off speeds with Ultradur® B 6550 L, B 6550 LN, B 6551 LNI R01, B 6554 LNI and B 6560 M2 FC TF, the ratio of the pipe die diameter to the internal diameter of the sizing sleeve must range from about 2 : 1 to 2.5 : 1. The die gap of the pipe extrusion head should be 3 to 4 times the size of the desired wall thickness of the tube. A processing example for the production of tube is described in Table 6.

Tube dimensions	ø 6 mm · 1 mm
Extruder	ø 45 mm, L/D=20
Screw – Section length – Flight depths	$L_E = 9D, L_K = 3D, L_P = 8D$ $h_1/h_2 = 6.65/2.25$
Temperature settings – Extruder – Adapter – Die	250/240/230 °C 225 °C 215 °C
Extrusion mold – Die diameter – Mandrel diameter – Gap	14 mm 6.8 mm 3.6 mm
Waterbath-vacuum calibration unit – Sizing plate diameter – Water temperature	6.15 mm 19 °C
Screw speed	72 U/min
Take-off speed	20 m/min
Output	24 kg/h

Table 6: Processing example for the production of tubes from Ultradur® B 6550 L und Ultradur® B 6550 LN

Production of film

Flat film made from Ultradur® B 4500, B 6551 LNI R01 and B 6554 LNI is manufactured by the usual method using sheet dies and chill rolls. With appropriate cooling the films have very good transparency and at the same time they are rigid and have good surface slip. A processing example is shown in Table 7. Ultradur® B 4500 film of 12 - 100 µm gauge can be produced under appropriate production conditions with high transparency, good surface slip and high rigidity. The properties of such films are given in Table 8. Adhesive-tape resistant vapor deposition of aluminum is readily possible on these films. The barrier properties are improved still further by the vapor deposition. Ultradur® B 4500 monofilm or multilayer (with PE) can be sterilized on their own and in composites without risk of damage using superheated steam at 120 °C to 140 °C, ethylene oxide or ionizing radiation (2.5 · 104 J/kg). They are therefore also suitable as a packaging material for sterilized goods. The films made from Ultradur® B 4500 can be oriented uniaxially or biaxially.

Ultradur® B 4500 monofilm can be welded by means of ultrasonics. Joining is also possible using parting line welding based on the thermal impulse principle. In this case, however, postcrystallization produces a white zone in the area of the welded joint.

Dimensions	Gauge approx. 30 µm, width 650 mm
Screw – Section lengths – Flight depths	$D = 63.5 \text{ mm}, L/D = 24$ $L_E = 7D, L_K = 5D, L_P = 12D$ $h_1/h_2 = 8.5/2.5$
Screen pack	400, 900, 2500, 3600 mesh count/cm ²
Die	width 800 mm, die gap 0.5 mm
Heater band temperatures	230/245/255/265 °C, die 225 °C
Melt temperature	280 °C
Melt pressure	75 bar
Chill rolls – Temperature – Diameter	approx. 55 °C 450 mm
Screw speed	40 U/min
Take-off speed	26 m/min
Output	44 kg/h

Table 7: Film extrusion example for Ultradur® B 4500

	Unit	Value	Test method
Mechanical properties			
Yield stress σ_s (para. & perp.)	MPa	30-35	ISO 527
Tear strength σ_s (para. & perp.)	MPa	75-80	ISO 527
Strain at break ϵ_s (para. & perp.)	%	450-500	ISO 527
Gas transmission			
– Water vapor transmission rate	g/(m ² ·d)	10	ASTM F 1249
– Nitrogen gas transmission rate	ml/(m ² ·d)	12	ASTM D 3985-81
– Oxygen permeability	ml/(m ² ·d·bar)	60	
– Carbon dioxide permeability	ml/(m ² ·d·bar)	550	
Optical properties			
Haze	%	1	ASTM D 1003

Table 8: Properties of film made from Ultradur® B 4500 (film thickness approx. 25 µm, measured in standard atmosphere, ISO 291, after saturation)

Production of monofilaments and bristles

Monofilaments made from Ultradur® B 2550 for the fabric sector are produced on commercial extruders. The usual monofilament diameters lie in the range of 0.5mm to 1.0mm. To achieve good uniformity of diameter water spinning bath temperatures of 60°C to 80°C are required when cooling. In comparison with polyesters made from polyethylene terephthalate Ultradur® exhibits better resistance to hydrolysis.

Bristles for e.g. toothbrushes can be extruded from Ultradur® B 2550. Finishing treatments in the autoclave or in hot water baths for improving the ability to return to the upright position are not absolutely necessary. Toothbrush bristles made from Ultradur® are distinguished primarily by low water absorption, high resistance to abrasion and excellent powers of return to the upright position. Examples of the production of monofilaments and bristles from Ultradur® are presented in Table 9.

Diameter	Monofilaments 0.70mm	Bristles 0.20mm
Extruder	ø 45mm L/D = 25	
Screw	three-section screw, 6D/7D/9D+3D	
Die		
– Die head diameter	2.4mm	0.65mm
– Die head length	4.8mm	0.90mm
Temperature control		
– Section 1	265°C	260°C
– Section 2	275°C	265°C
– Section 3	270°C	260°C
– Section 4	265°C	255°C
– Head	270°C	260°C
– Pump	270°C	260°C
– Die	270°C	260°C
– Melt	270°C	260°C
Water bath temperature	70°C	45°C
Die spacing	160mm	40mm
Cooling path length	900mm	780mm
Take-off rate	20m/min	25m/min
Stretching temperature (hot air), 1 st heater	155°C	160°C
Stretching unit 1	80m/min	112.5m/min
Stretching temperature (hot air), 2 nd heater	235°C	–
Stretching unit 2	110m/min	–
Fixing temperature, 3 rd heater, 20m/min	230°C	200°C
Fixing unit	101.2m/min	101.3m/min
Stretching ratio 1	1:4.0	1:4.5
Stretching ratio 2	1:1.38	–
Overall stretching ratio	1:5.5	1:4.5
Mechanical shrinkage	8%	10%

Table 9: Processing examples for the production of monofilaments and bristles from Ultradur®



Snowboard

Fabrication and finishing processes

Machining

Semi-finished parts and moldings made from Ultradur® can be readily machined with cutting tools. This includes drilling, turning on a lathe, tapping, sawing, milling, filing and grinding. Special tools are not necessary. Machining is possible using standard tools suitable for machining steel on all standard machine tools.

As a general rule cutting speeds should be high and feed rate low with rapid removal of shavings and chips. The cutting tools must always be sharp. Since Ultradur® has a high softening point cooling is generally not required. However, the working conditions must be chosen in such a way that the temperatures do not exceed 200°C.

Joining methods

Parts made from Ultradur® can be joined at low cost by a variety of methods. The mechanical properties of Ultradur®, especially its toughness, allow the use of self-tapping screws. Ultradur® parts can be connected without difficulty to one another or to parts made from other materials by means of rivets and bolts. Ultradur®'s outstanding elasticity and strength, even at high temperatures, enables economic manufacture of high-performance snap- and press-fitting connectors.

In general, parts made of Ultradur® are suitable for adhesive bonding to parts made of Ultradur® or other materials. Adhesive properties are a function of the entire system and therefore the joining partners and the adhesive have to be matched to gain an optimum result.

Attention has to be paid to the data sheets and processing guidelines of the adhesive suppliers, especially to the ones regarding pretreatment of the surfaces. Usually, an adequate drying, roughening, cleaning, degreasing and/or activating of the surfaces is recommended. Depending on the requirements, it is recommended to implement quality assurance measures like quality controls of the adhesive bonding according to the established test standards.

Known methods for welding Ultradur® include heating-element and ultrasonic welding as well as spin and vibration welding. As an especially gentle joining technique laser welding can be used, e. g. when sensitive electrical assemblies must not be submitted to the mechanical and thermal stresses of the other joining methods. Only high-frequency welding is not feasible for this plastic on account of the low dielectric loss factor. Due to its range of variation the ultrasonic joining technique in particular affords the possibility of integrating the bonding of mass-produced injection-molded parts efficiently and synchronously into fully automated production flows. Design of the mating surfaces in line with the welding technique together with optimum processing parameters are the prerequisites for obtaining high-quality welded joints. It is therefore important to consider at the design stage how parts are to be welded and then to design the mating surfaces accordingly.

Air flow sensor





Steering angle sensor

Further details can be found in the corresponding guidelines of the DVS (Deutscher Verband für Schweißtechnik=German association for welding technology). Ultrasound also can be used to embed metal inserts into preformed holes.

Laser marking

Very good results are also obtained with laser-printing on Ultradur® moldings. There is an abundance of experience in this area which the Ultraplaste Infopoint can inform customers about. Special tints for high-contrast laser-lettering are available. Our LS types are especially suited for that method.



Door handle module

General Information

Safety notes

Safety precautions during processing

If processing takes place under the recommended conditions (according to the product-specific processing data sheets), melts made of Ultradur® are thermally stable and do not pose any hazards due to molecular degradation or the evolution of gases and vapors. Like all thermoplastic polymers, however, Ultradur® decomposes on exposure to excessive thermal stresses, e. g. when it is overheated or as a result of cleaning by burning off. In such cases gaseous decomposition products are formed. Further information can be found in the product-specific safety data sheets.

When Ultradur® is properly processed and there is adequate suction at the die, no risks to health are to be expected. The workplace should be adequately ventilated when Ultradur® is being processed.

Incorrect processing includes e.g. high thermal stresses and long residence times in the processing machine. In these cases there is the risk of elimination of pungent-smelling vapors and gases which can be a hazard to health. Such a failure additionally becomes apparent due to brownish burn marks on the moldings.

This is remedied by ejection of the machine contents into the open air and reducing the cylinder temperature at the same time. Rapid cooling of the damaged material, e. g. in a water bath, reduces nuisances caused by odors. In general measures should be taken to ensure ventilation and venting of the work area, preferably by means of an extraction hood over the cylinder unit. Halogen-containing flame-retardant Ultradur® grades can give rise to corrosive and harmful degradation products due to overheating or long residence times of the melt in the cylinder.

When relatively long downtimes occur it is therefore necessary to flush the cylinder empty or to purge it with an Ultradur® grade which is not flame-retardant and lower the temperature. In general we recommend careful extraction by suction in the area of the nozzle. In the event of fires involving flame-retardant grades containing halogen, toxic compounds can be produced which should not be inhaled. Further information can be found in the safety data sheets.

Toxicology – procedures

Provided Ultradur® is processed correctly and the work areas are well-ventilated, there are no known adverse effects for people working with it.

Food regulations

Some standard-grades of the Ultradur® product line are in conformity with the current regulations for food contact in Europe and USA with respect to their composition and manufacturing conditions. The conformity of these products is furthermore guaranteed by the production in compliance with the GMP (good manufacturing practice) Food Contact standard. BASF will be glad to provide the relevant confirmations on request (plastics.safety@basf.com).

Delivery and storage

Ultradur® is supplied as cylindrical or lenticular granules. The products are normally dried ready for processing and supplied in moisture-tight packaging.

Ultradur® is not classed as hazardous within the meaning of CLP Regulation (EC) no. 1272/2008 and is therefore not considered a dangerous good for transportation. Further information can be found in the product safety data sheets.

Ultradur® is classed as not hazardous to water. Standard packaging is 25 kg bags and 1,000 kg octabins; it can also be supplied in other types of packaging or in silo trucks by agreement.

All containers are tightly sealed and should not be opened until immediately prior to use.

Storage and transport

Ultradur® can be stored for unlimited periods, even after being stored for long periods in dry, ventilated rooms. The moisture content of Ultradur® during processing should generally amount to $\leq 0.04\%$. In order to guarantee safe production, pre-drying should generally be the rule and the machine should be loaded using a closed conveyor system. Pre-drying is also recommended for the addition of batches, e.g. in the case of self-coloring.

In order to prevent the formation of condensation, containers stored in unheated rooms must only be opened once they have attained the temperature in the processing area. Further information regarding storage can be found in the product-specific safety data sheets.

Color

Ultradur® is supplied in both colored and uncolored form. Uncolored Ultradur® has a white-opaque natural color. A number of products are available in shades of black. Individual grades can be supplied in a variety of shades upon request.

Disposal

All Ultradur® grades can be incinerated in accordance with official regulations. The calorific value of unreinforced grades is 29,000 to 32,000 kJ/kg (Hu according to DIN 51900).

Flame-retardant grades of Ultradur® containing halogen must be disposed of as hazardous waste in line with the national waste disposal requirements and local regulations.

Recovery

Like other production wastes, sorted Ultradur® waste materials, e.g. ground up injection-molded parts and the like, can be fed back to a certain extent into processing depending on the grade and the demands placed on it. In order to produce defect-free injection-molded parts containing regenerated material the ground material must be clean and dry (drying is usually necessary). It is also essential that no thermal degradation has occurred in the preceding processing. The maximum permissible amount of regrind that can be added should be determined in trials. It depends on the grade of Ultradur®, the type of injection-molded part and on the requirements.

The properties of the parts, e.g. impact and mechanical strength, and also processing behavior, such as flow properties, shrinkage and surface finish, can be markedly affected in some grades by even small amounts of reground material.

(Integrated) management system

QHSE management

Quality, environment and energy management are key elements of BASF's corporate policy. Customer satisfaction is a significant target. The ongoing improvement of our products and services in terms of quality, environment, safety and health is our primary goal.

The BASF business unit Performance Materials Europe uses an integrated management system that covers issues such as quality, environment (including energy), Responsible Care®, safety and health.

The business unit is recognized by an accredited certification company for its:

- Quality Management System according to ISO 9001 and ISO TS 16949
- Environment Management System according to ISO 14001
- Energy Management System according to ISO 50001

Nomenclature

Structure

The name of Ultradur® commercial products generally follows the scheme below:

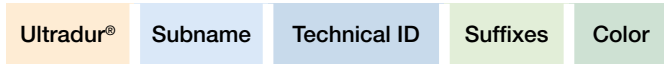

Subnames

Subnames are optionally used in order to particularly emphasize a product feature that is characteristic of part of a range.

Example of subnames:

LUX Particularly high transparency to the radiation from Nd:YAG lasers and lasers of a similar wavelength, e.g. diode lasers

Technical ID

The technical ID is made up of a series of letters and numbers which give hints about the polymer type, the melt viscosity and the finish with reinforcing agents, fillers or modifiers. The following classification scheme is found with most products:

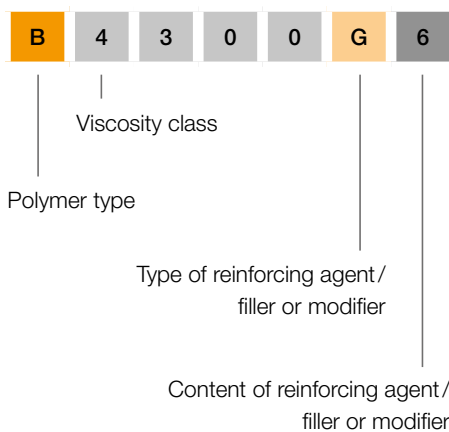

Letters for identifying polymer types

- B Polybutylene terephthalate (PBT) or polybutylene terephthalate + polyethylene terephthalate (PET)
- S Polybutylene terephthalate + acrylonitrile styrene acrylate polymer (ASA)

Numbers for identifying viscosity classes

- 1 Very low viscosity
- 2 Low viscosity
- 4 Medium viscosity
- 6 High viscosity

Letters for identifying reinforcing agents, fillers, and modifiers

- G Glass fibers
- C Carbon fibers
- K Glass beads
- M Minerals
- Z Impact modifiers
- GM Glass fibers in combination with minerals

Key numbers for describing the content of reinforcing agents and fillers

- 2 approx. 10 % by mass
- 3 approx. 15 % by mass
- 4 approx. 20 % by mass
- 6 approx. 30 % by mass
- 10 approx. 50 % by mass
- 12 approx. 60 % by mass

In the case of combinations of glass fibers with minerals, the respective contents are indicated by two numbers, e.g.

- GM13 approx. 5 % by mass of glass fibers and approx. 15 % by mass of minerals

Suffixes

Suffixes are optionally used in order to indicate specific processing or application-related properties. They are frequently acronyms whose letters are derived from the English term.

Examples of suffixes:

Aqua®	Suitable for drinking water applications
FC	Food Contact; meets specific regulatory requirements for applications in contact with food
High Speed	High flowability of the melt
HR	Hydrolysis Resistant, increased hydrolysis resistance
LS	Laser Sensitive, can be marked with Nd:YAG laser
LT	Laser Transparent, can be penetrated well with Nd:YAG lasers and lasers of a similar wavelength
PRO	Profile Covered Raw Materials Only; fulfill specific regulatory requirements and demands for medical device applications

Color

The color is generally made up of a color name and a color number.

Examples of colors:

Uncolored
Black 00110
Black 05110

Moving platen



Subject index

Automotive engineering 4 f.

Back pressure 29

Behavior

– on brief exposure to heat 20

– on exposure to weather 25

– under cyclic loads 18

– under flexural fatigue strength 18

– under long-term static loading 17

Change of material 27

Construction industry 23

Delivery 40 f.

Drinking water contact 11

Drying 26 f.

Electrical engineering and electronics 6 f., 23

Electrical properties 22

Extrusion 34 ff.

Fabrication 38 f.

Finishing processes 38 f.

Fire behavior 23

Flame-retardant grades 13

Flexural fatigue strength 18

Flow behavior 30

Flow properties 10

Food contact 11

Food regulations 40

General information 40 ff.

General notes 23, 26 f.

Grades with excellent flowability 12

Grades with special properties 13

Heat aging resistance 20 f.

Household applications 8 f.

Hydrolysis resistance 11, 13, 21

Impact strength 16

Injection molding 28 ff.

Injection speed 30

Injection unit 28

Insulating materials 23

Integrated management system 41

Joining methods 38 f.

Laser marking 39

Laser transparency 11

Laser welding 13

Low-temperature impact resistance 16

Machining 38

Mechanical properties 14 ff.

Medical applications 11

Metering 29

Moisture 26

Mold surface temperature 30

Procedures 40

Processing 26 ff.

Processing temperature 30

Product range 10 ff.

Production of

– film 36

– monofilaments and bristles 37

– semi-finished products and profile sections 35

– sheet 35

– tubes 36

Production stoppages 27

Properties 10 ff.

QHSE management 41

Recovery 41

Reinforced grades 10, 12

Reinforced grades with low warpage 10, 12

Reprocessing 27

Residence time 30

Resistance to chemicals and behavior
on exposure to weather 24 f.

Safety notes 40 f.

Safety precautions during processing 40

Screw geometry 34

Self-coloring 27

Sprue system 28 f.

Storage 40 f.

Tests 23

Thermal properties 20 f.

Tool design 28 f.

Toughness 16

Toxicology 40

Transport 41

Transportation 23

Tribological properties 19

Unreinforced grades 10, 12

Warpage 10, 12, 32

For your notes

Selected Product Literature for Ultradur®:

- Ultradur® – Product Brochure
- Ultradur® – Product Range
- Ultramid®, Ultradur® and Ultraform® – Resistance to Chemicals

Note

The data contained in this publication are based on our current knowledge and experience. In view of the many factors that may affect processing and application of our product, these data do not relieve processors from carrying out own investigations and tests; neither do these data imply any guarantee of certain properties, nor the suitability of the product for a specific purpose. Any descriptions, drawings, photographs, data, proportions, weights etc. given herein may change without prior information and do not constitute the agreed contractual quality of the product. It is the responsibility of the recipient of our products to ensure that any proprietary rights and existing laws and legislation are observed. (September 2022)

Further information on Ultradur® (PBT)

Product Brochure can be found on the internet:

www.ultradur.basf.com

Please visit our websites:

www.plastics.basf.com

www.plastics.basf.de

If you have any technical questions about the products, please contact the Infopoints:

